

Enerpac hydraulic cylinders are available in hundreds of different configurations. Whatever the industrial application... lifting, pushing, pulling, bending, holding... whatever the force capacity, stroke length, or size restrictions... single- or double-acting, solid or hollow plunger, you can be sure that Enerpac has the cylinder to suit your high force application. Enerpac jacking cylinders fully comply to ASME B30.1 (except BRD-Series).



GR2 Bearing Technology

The exclusive GR2 is a unique bearing design on RC-Series DUO general purpose cylinders which absorbs eccentric load stresses to protect your cylinder against abrasion, over-extending or plunger blow-outs and jamming or top-end mushrooming. As a result, RC-Series DUO cylinders provide long, trouble-free operation.

Improved saddle retention

Hardened plunger saddle protects plunger end during all lifting operations. Easily removable for access to plunger mounting threads.

Thread protector

Protector is easily attached and removed with oily hands or whilst wearing gloves.

Easy assembly and disassembly

External access to fasteners requires only standard shop tools for simplified maintenance.

Heavy-Duty return spring

Pre-tensioned return spring improves retraction performance, reducing retraction times.

Unique GR2 Bearing System

GR2 design surrounds seal of longer stroke models for improved life and reduced bearing loads. Bearing surface area increases side-load resistance and significantly improves cylinder life.



Coupler Protector

Coupler Dust Cap has new shape and more pliable material for easy push-on/pull-off operation. Protector is easily attached and removed with oily hands or whilst wearing gloves.













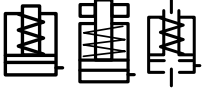



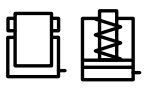



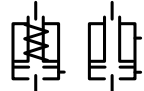









Easy assembly and disassembly

External access to fasteners requires only standard shop tools for simplified maintenance.



Note: The cut-away drawing is representative of typical cylinder construction, and may not represent all cylinders in this section.

Cylinders and Lifting Products Section Overview

Capacity ¹⁾ ton (kN)	Stroke Range (mm)	Cylinder type and functions	Series	Page	
5 - 95 (45 - 933)	16 - 362	General Purpose Cylinders, Single-Acting (incl. accessories) 	RC	 6 ▶	
20 - 150 (229 - 1589)	50 - 250	Aluminium Cylinders, Single-Acting, Lock Nut, Hollow Plunger 	RAC	 12 ▶	
			RACL		14 ▶
			RACH		16 ▶
20 - 150 (229 - 1589)	50 - 250	Aluminium Cylinders, Double-Acting, Solid Plunger 	RAR	 18 ▶	
5 - 520 (45 - 5114)	6 - 62	Low Height Lock Nut Cylinders, Flat-Jac® and Low Height Cylinders, Single-Acting 	LPL	 20 ▶	
			RSM		22 ▶
			RCS		
2,5 - 50 (24 - 505)	127 - 154	Pull Cylinders, Single-Acting 	BRC BRP	 24 ▶	
13 - 145 (125 - 1429)	8 - 258	Hollow Plunger Cylinders, Single- and Double-Acting 	RCH	 26 ▶	
			RRH		28 ▶
4 - 23 (35 - 222)	28 - 260	Precision Production Cylinders, Double-Acting (incl. mounting attachments) 	BRD	 30 ▶	
10 - 520 (101 - 5108)	16 - 1219	Long Stroke Cylinders, Double-Acting 	RR	 32 ▶	
50 - 1000 (550 - 10.644)	50 - 300	High Tonnage Cylinders, Single- and Double-Acting 	HCG	 36 ▶	
			HCR		44 ▶
50 - 1000 (550 - 10.644)	50 - 300	High Tonnage Lock Nut Cylinders, Single-Acting 	HCL	 48 ▶	
5 - 95 (45 - 933)	38 - 362	Cylinder - Pump Sets, Single-Acting 	SC	 52 ▶	
1 - 45 (8,9 - 435)	11 - 156	Extreme Environment Products Power Box, Portable Tool Sets 	RC, P, V	 54 ▶	
			SC, SL		55 ▶
			SR, SW		
2 - 150 (20 - 1335)	62 - 460	Aluminium and Steel Jacks Industrial Steel Bottle Jacks 	JH, JHA	 56 ▶	
			GBJ		57 ▶
54 - 181 (533 - 1778)	356 - 686	POW'R RISER® Mobile Lifting Jacks 	PR	 58 ▶	
181 (1778)	356 - 622	POW'R LOCK® Mobile Lift System 	PL	 60 ▶	

¹⁾ All ton values specified in this catalog are metric ton and are for cylinder class identification only. Please refer to the kN data for calculations.

RC-Series DUO, Single-Acting Cylinders

▼ From left to right: RC-506, RC-50, RC-2510, RC-154, RC-10010, RC-55, RC-1010



- **Unique GR2 Bearing Design, reduces wear, extending life**
- **Collar threads, plunger threads and base mounting holes enable easy fixturing (on most models)**
- **Designed for use in all positions**
- **High strength alloy steel for durability**
- **Redesigned cylinder thread protector for ease of use**
- **Heavy-duty, pretensioned spring improves retraction speed**
- **Baked enamel finish for increased corrosion resistance**
- **CR-400 coupler and dust cap included on all models**
- **Plunger wiper reduces contamination, extending cylinder life.**

▼ *Foundation repair: to re-stabilize the foundation, the 308 ton silo needed to be lifted, levelled and structurally supported. 25 ton RC-Series hydraulic jacks were attached to a bracket on the top of each steel pier. Powered by a Z-Class pump, the hydraulic jacks applied 20 ton of force at each placement to lift the silo 5,1 cm.*



The Industry Standard General Purpose Cylinder



Saddles

All RC cylinders (except RC-50, 101) are equipped with hardened removable grooved saddles. For tilt and flat saddles, see the RC-Series accessory page.

Page: 10



Base Plates

To ensure the stability of cylinders for lifting applications, base plates are available for 10, 25 and 50 ton RC cylinders.

Page: 10



Specialty Attachments

For solving all kinds of application problems, specialty attachments are available for 5, 10 and 25 ton RC cylinders.

Page: 161

▼ *Synchronous lifting set-up for 200 ton petrochemical process module using twelve RC-2510 cylinders. To ensure the stability of the cylinders JBI-25 base plates are installed.*



Single-Acting, General Purpose Cylinders



GR2 Bearing Technology

The exclusive GR2 is a unique bearing design on RC-Series DUO cylinders which absorbs eccentric load stresses to protect your cylinder against

abrasion, over-extending or plunger blow-outs and jamming or top-end mushrooming. As a result, RC-Series DUO cylinders provide long, trouble-free operation.

▼ QUICK SELECTION CHART

For complete technical information see next page.

Cylinder Capacity	Stroke	Model Number	Cylinder Effective Area	Oil Capacity	Collapsed Height	
ton (kN)	(mm)		(cm ²)	(cm ³)	(mm)	(kg)
5 (45)	16	RC-50	6,5	10	41	1,0
	25	RC-51	6,5	16	110	1,0
	76	RC-53	6,5	50	165	1,5
	127	RC-55 *	6,5	83	215	1,9
	177	RC-57	6,5	115	273	2,4
	232	RC-59	6,5	151	323	2,8
10 (101)	26	RC-101	14,5	38	89	1,8
	54	RC-102 *	14,5	78	121	2,3
	105	RC-104	14,5	152	171	3,3
	156	RC-106 *	14,5	226	247	4,4
	203	RC-108	14,5	294	298	5,4
	257	RC-1010 *	14,5	373	349	6,4
	304	RC-1012	14,5	441	400	6,8
	356	RC-1014	14,5	516	450	8,2
15 (142)	25	RC-151	20,3	51	124	3,3
	51	RC-152	20,3	104	149	4,1
	101	RC-154 *	20,3	205	200	5,0
	152	RC-156 *	20,3	308	271	6,8
	203	RC-158	20,3	411	322	8,2
	254	RC-1510	20,3	516	373	9,5
	305	RC-1512	20,3	619	423	10,9
	356	RC-1514	20,3	723	474	11,8
25 (232)	26	RC-251	33,2	86	139	5,9
	50	RC-252 *	33,2	166	165	6,4
	102	RC-254 *	33,2	339	215	8,2
	158	RC-256 *	33,2	525	273	10,0
	210	RC-258	33,2	697	323	12,2
	261	RC-2510	33,2	867	374	14,1
	311	RC-2512	33,2	1033	425	16,3
	362	RC-2514 *	33,2	1202	476	17,7
30(295)	209	RC-308	42,1	880	387	18,1
50 (498)	51	RC-502	71,2	362	176	15,0
	101	RC-504	71,2	719	227	19,1
	159	RC-506 *	71,2	1131	282	23,1
	337	RC-5013	71,2	2399	460	37,6
75 (718)	156	RC-756	102,6	1601	285	29,5
	333	RC-7513	102,6	3417	492	59,0
95 (933)	168	RC-1006	133,3	2239	357	59,0
	260	RC-10010	133,3	3466	449	72,6

* Available as set, see note on this page.

RC Series



Capacity:

5 - 95 ton

Stroke:

16 - 362 mm

Maximum Operating Pressure:

700 bar



Think Safety

Manufacturer's rating of load and stroke are maximum safe limits.

Good practice encourages using only 80% of these ratings.

Page: 260



Lightweight Aluminium Cylinders

If you need a higher cylinder capacity-to-weight-ratio the RAC-Series are the perfect choice.

Page: 13



Gauges

Minimize the risk of overloading and ensure long, dependable service from your equipment. Refer

to the System Components Section for a full range of gauges.

Page: 114

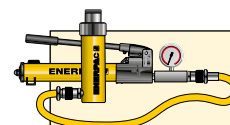

Cylinder-Pump Sets

All cylinders marked with an * are available as sets (cylinder, gauge, couplers, hose and pump) for your ordering convenience.

Page: 52

RC-Series DUO, Single-Acting Cylinders

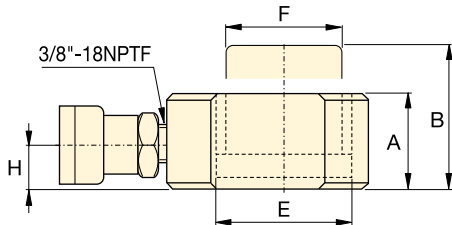
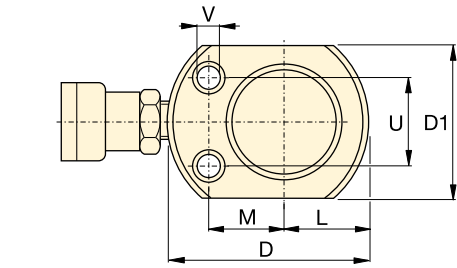

RC-50

RC-101 only
(U1 = 19 mm)

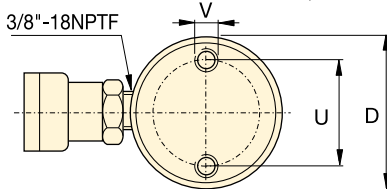
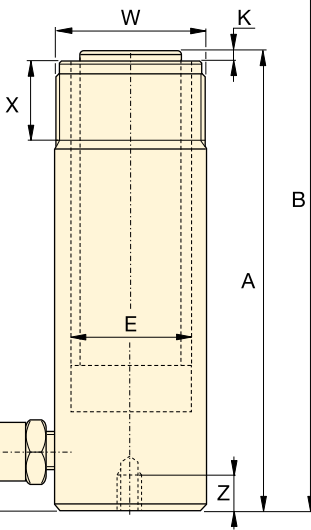
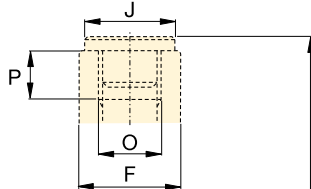
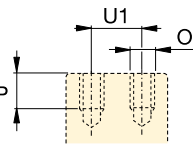

RC-51 - RC-5013

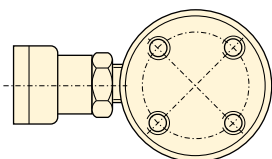

RC-1006, RC-10010



Speed Chart

See the Enerpac Cylinder Speed Chart in our 'Yellow Pages' to determine your approximate cylinder speed.

Page: **255**

◀ For full features see previous page.

Cylinder Capacity	Stroke	Model Number	Cylinder Effective Area	Oil Capacity	Collapsed Height	Extended Height	Outside Dia.
ton (kN)	(mm)		(cm ²)	(cm ³)	A (mm)	B (mm)	D (mm)
5 (45)	16	RC-50 ²⁾	6,5	10	41	57	58 ³⁾
	25	RC-51	6,5	16	110	135	38
	76	RC-53	6,5	50	165	241	38
	127	RC-55 ¹⁾	6,5	83	215	342	38
	177	RC-57	6,5	115	273	450	38
	232	RC-59	6,5	151	323	555	38
10 (101)	26	RC-101 ⁴⁾	14,5	38	89	115	57
	54	RC-102 ¹⁾	14,5	78	121	175	57
	105	RC-104	14,5	152	171	276	57
	156	RC-106 ¹⁾	14,5	226	247	403	57
	203	RC-108	14,5	294	298	501	57
	257	RC-1010 ¹⁾	14,5	373	349	606	57
	304	RC-1012	14,5	441	400	704	57
	356	RC-1014	14,5	516	450	806	57
15 (142)	25	RC-151	20,3	51	124	149	69
	51	RC-152	20,3	104	149	200	69
	101	RC-154 ¹⁾	20,3	205	200	301	69
	152	RC-156 ¹⁾	20,3	308	271	423	69
	203	RC-158	20,3	411	322	525	69
	254	RC-1510	20,3	516	373	627	69
	305	RC-1512	20,3	619	423	728	69
	356	RC-1514	20,3	723	474	830	69
25 (232)	26	RC-251	33,2	86	139	165	85
	50	RC-252 ¹⁾	33,2	166	165	215	85
	102	RC-254 ¹⁾	33,2	339	215	317	85
	158	RC-256 ¹⁾	33,2	525	273	431	85
	210	RC-258	33,2	697	323	533	85
	261	RC-2510	33,2	867	374	635	85
	311	RC-2512	33,2	1033	425	736	85
	362	RC-2514 ¹⁾	33,2	1202	476	838	85
30 (295)	209	RC-308	42,1	880	387	596	101
50 (498)	51	RC-502	71,2	362	176	227	127
	101	RC-504	71,2	719	227	328	127
	159	RC-506 ¹⁾	71,2	1131	282	441	127
	337	RC-5013	71,2	2399	460	797	127
75 (718)	156	RC-756	102,6	1601	285	441	146
	333	RC-7513	102,6	3417	492	825	146
95 (933)	168	RC-1006	133,3	2239	357	525	177
	260	RC-10010	133,3	3466	449	709	177

¹⁾ Available as set, see note on page 7.

²⁾ RC-50 cylinder has a non removable grooved saddle and no collar thread.

³⁾ RC-50: D1 = 41 mm, L = 20 mm, M = 25 mm.

⁴⁾ RC-101 has plunger thread and non-removable saddle.

Single-Acting, General Purpose Cylinders

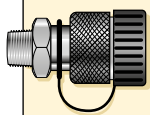

Couplers Included!

CR-400 couplers included on all models. Fits all HC-Series hoses.

Capacity:
5 - 95 ton

Stroke:
16 - 362 mm

Maximum Operating Pressure:
700 bar

RC Series



Cylinder Bore Dia. E (mm)	Plunger Dia. F (mm)	Base to Adv. Port H (mm)	Saddle Dia. J (mm)	Saddle Protr. from Plgr. K (mm)	Plunger Internal Thread O	Plunger Thread Length P (mm)	Base Mounting Holes			Collar Thread W	Collar Thread Length X (mm)	 (kg)	Model Number
							Bolt Circle U (mm)	Thread V	Thd. Depth Z (mm)				
28,7	25,4	19	2)	2)	2)	2)	28	5,6 mm	—	—	—	1,0	RC-50 ²⁾
28,7	25,4	19	25	6	3/4" - 16 UN	14	25	1/4" - 20 UN	14	1 1/2" - 16 UN	28	1,0	RC-51
28,7	25,4	19	25	6	3/4" - 16 UN	14	25	1/4" - 20 UN	14	1 1/2" - 16 UN	28	1,5	RC-53
28,7	25,4	19	25	6	3/4" - 16 UN	14	25	1/4" - 20 UN	14	1 1/2" - 16 UN	28	1,9	RC-55 ¹⁾
28,7	25,4	19	25	6	3/4" - 16 UN	16	25	1/4" - 20 UN	14	1 1/2" - 16 UN	28	2,4	RC-57
28,7	25,4	19	25	6	3/4" - 16 UN	16	25	1/4" - 20 UN	14	1 1/2" - 16 UN	28	2,8	RC-59
42,9	38,1	19	—	—	#10 - 24 UN	6	39	5/16" - 18 UN	12	2 1/4" - 14	26	1,8	RC-101 ⁴⁾
42,9	38,1	19	35	6	1" - 8 UN	19	39	5/16" - 18 UN	12	2 1/4" - 14 UN	26	2,3	RC-102 ¹⁾
42,9	38,1	19	35	6	1" - 8 UN	19	39	5/16" - 18 UN	12	2 1/4" - 14 UN	26	3,3	RC-104
42,9	38,1	19	35	6	1" - 8 UN	19	39	5/16" - 18 UN	12	2 1/4" - 14 UN	26	4,4	RC-106 ¹⁾
42,9	38,1	19	35	6	1" - 8 UN	19	39	5/16" - 18 UN	12	2 1/4" - 14 UN	26	5,4	RC-108
42,9	38,1	19	35	6	1" - 8 UN	19	39	5/16" - 18 UN	12	2 1/4" - 14 UN	26	6,4	RC-1010 ¹⁾
42,9	38,1	19	35	6	1" - 8 UN	19	39	5/16" - 18 UN	12	2 1/4" - 14 UN	26	6,8	RC-1012
42,9	38,1	19	35	6	1" - 8 UN	19	39	5/16" - 18 UN	12	2 1/4" - 14 UN	26	8,2	RC-1014
50,8	41,4	19	38	9	1" - 8 UN	25	48	3/8" - 16 UN	12	2 3/4" - 16 UN	30	3,3	RC-151
50,8	41,4	19	38	9	1" - 8 UN	22	48	3/8" - 16 UN	12	2 3/4" - 16 UN	30	4,1	RC-152
50,8	41,4	19	38	9	1" - 8 UN	22	48	3/8" - 16 UN	12	2 3/4" - 16 UN	30	5,0	RC-154 ¹⁾
50,8	41,4	25	38	9	1" - 8 UN	25	48	3/8" - 16 UN	12	2 3/4" - 16 UN	30	6,8	RC-156 ¹⁾
50,8	41,4	25	38	9	1" - 8 UN	25	48	3/8" - 16 UN	12	2 3/4" - 16 UN	30	8,2	RC-158
50,8	41,4	25	38	9	1" - 8 UN	25	48	3/8" - 16 UN	12	2 3/4" - 16 UN	30	9,5	RC-1510
50,8	41,4	25	38	9	1" - 8 UN	25	48	3/8" - 16 UN	12	2 3/4" - 16 UN	30	10,9	RC-1512
50,8	41,4	25	38	9	1" - 8 UN	25	48	3/8" - 16 UN	12	2 3/4" - 16 UN	30	11,8	RC-1514
65,0	57,2	25	50	10	1 1/2" - 16 UN	25	58	1/2" - 13 UN	19	3 5/16" - 12 UN	49	5,9	RC-251
65,0	57,2	25	50	10	1 1/2" - 16 UN	25	58	1/2" - 13 UN	19	3 5/16" - 12 UN	49	6,4	RC-252 ¹⁾
65,0	57,2	25	50	10	1 1/2" - 16 UN	25	58	1/2" - 13 UN	19	3 5/16" - 12 UN	49	8,2	RC-254 ¹⁾
65,0	57,2	25	50	10	1 1/2" - 16 UN	25	58	1/2" - 13 UN	19	3 5/16" - 12 UN	49	10,0	RC-256 ¹⁾
65,0	57,2	25	50	10	1 1/2" - 16 UN	25	58	1/2" - 13 UN	19	3 5/16" - 12 UN	49	12,2	RC-258
65,0	57,2	25	50	10	1 1/2" - 16 UN	25	58	1/2" - 13 UN	19	3 5/16" - 12 UN	49	14,1	RC-2510
65,0	57,2	25	50	10	1 1/2" - 16 UN	25	58	1/2" - 13 UN	19	3 5/16" - 12 UN	49	16,3	RC-2512
65,0	57,2	25	50	10	1 1/2" - 16 UN	25	58	1/2" - 13 UN	19	3 5/16" - 12 UN	49	17,7	RC-2514 ¹⁾
73,2	57,2	57	50	10	1 1/2" - 16 UN	25	—	—	—	3 5/16" - 12 UN	49	18,1	RC-308
95,2	79,5	33	71	2	—	—	95	1/2" - 13 UN	19	5" - 12 UN	55	15,0	RC-502
95,2	79,5	33	71	2	—	—	95	1/2" - 13 UN	19	5" - 12 UN	55	19,1	RC-504
95,2	79,5	35	71	2	—	—	95	1/2" - 13 UN	19	5" - 12 UN	55	23,1	RC-506 ¹⁾
95,2	79,5	35	71	2	—	—	95	1/2" - 13 UN	19	5" - 12 UN	55	37,6	RC-5013
114,3	95,2	30	71	5	—	—	—	—	—	5 3/4" - 12 UN	44	29,5	RC-756
114,3	95,2	30	71	5	—	—	—	—	—	5 3/4" - 12 UN	44	59,0	RC-7513
130,3	104,9	41	71	2	—	—	140	3/4" - 10 UN	25	6 7/8" - 12 UN	44	59,0	RC-1006
130,3	104,9	41	71	2	—	—	140	3/4" - 10 UN	25	6 7/8" - 12 UN	44	72,6	RC-10010

Accessories for RC-Series Cylinders

▼ SELECTION CHART

For use with Cylinder Capacity ton (kN)	Saddles			Base Plate	Mounting Block	Clevis Eyes	
	Flat	Grooved ¹⁾	Tilt			Base ⁴⁾	Plunger
5 (45)	A-53F ²⁾	A-53G ²⁾	-	-	RB-5 ²⁾ , AW-51 ²⁾ , AW-53 ²⁾	REB-5 ²⁾	REP-5 ²⁾
10 (101)	A-12 ³⁾ , A-102F ³⁾	A-102G ³⁾	CAT-10 ³⁾	JBI-10	RB-10, AW-102	REB-10	REP-10 ³⁾
15 (142)	-	A-152G	CAT-10	-	RB-15	REB-15	REP-10
25 (232)	A-29 ⁵⁾	A-252G	CAT-50	JBI-25	RB-25	REB-25	REP-25
30 (295)	A-29 ⁵⁾	A-252G	CAT-50	-	RB-25	-	REP-25
50 (498)	-	-	CAT-100	JBI-50	-	-	-
75 (718)	-	-	CAT-100	-	-	-	-
95 (933)	-	-	CAT-100	-	-	-	-

¹⁾ Standard on 5-30 ton RC-cylinders ²⁾ Except RC-50 ³⁾ Except RC-101 ⁴⁾ Mounting screws are included. ⁵⁾ Used with Bender Sets.

▼ DIMENSION CHARTS

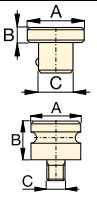
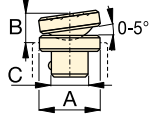
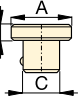
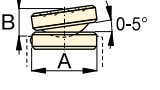
Model Number	Saddle Dimensions (mm)			A-53F, A-102F A-12, A-29	Model Number	Tilt Saddle Dimensions (mm)			Diagram
	A	B	C			A	B	C	
Flat					Tilt				
A-53F	25	6	17		CAT-10	35	20	22	
A-102F	35	6	22		CAT-50	50	23	35	
A-12	51	48	1"-8 UNC						
A-29	51	48	1 1/2"-16 UNC						
Grooved					Tilt				
A-53G	25	6	17		CAT-100	71	24	-	
A-102G	35	6	22						
A-152G	38	9	22						
A-252G	50	9	35						

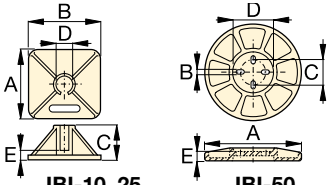
Model Number	Base Plate Dimensions (mm)					Diagram
	A	B	C	D	E	
JBI-10	228	228	135	58	20	
JBI-25	279	279	140	86	26	
JBI-50	304	15	95	131	31	

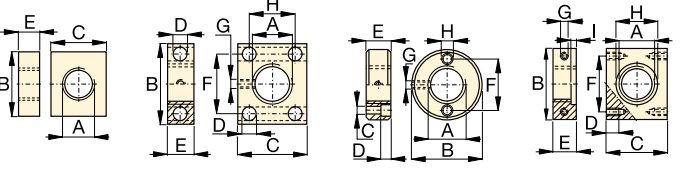
Model Number	Mounting Block Dimensions (mm)								Diagram
	A	B	C	D	E	F	G	H	
RB-5	1 1/2"-16UN	88	76	-	25	-	-	-	
AW-51	1 1/2"-16UN	70	59	10	24	54	1 1/4"-16 UN	41	
AW-53	1 1/2"-16UN	72	7	7	19	57	1 1/4"-20 UN	10	
RB-10	2 1/4"-14UN	114	88	-	25	-	-	-	
AW-102	2 1/4"-14UN	100	82	16	30	76	7/16"-20 UN	58	
RB-15	2 3/4"-16UN	101	114	-	38	-	-	-	
RB-25	3 5/16"-12UN	127	165	-	50	-	-	-	

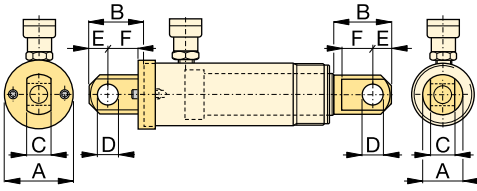
Type	Model Number	Clevis Eye Dimensions (mm)						Pin-to-Pin * (mm)	Diagram
		A	B	C	D	E	F		
Base ⁴⁾	REB-5	44	47	14	16	16	25	60,2	
	REB-10	63	66	25	22	25	35	78,0	
	REB-15	76	66	25	22	25	35	78,0	
	REB-25	95	79	38	31	31	41	87,6	
Plunger	REP-5	28	45	14	16	16	19	-	
	REP-10	42	61	25	22	25	28	-	
	REP-25	57	71	38	31	31	35	-	

⁴⁾ Mounting screws are included.

* Pin to Pin – REB and REP Clevises fitted. Add cylinder collapsed height.

The Enerpac Lightweight Aluminium Cylinders

▼ From left to right: RAC, RACL, RACH, RAR



- **Lightweight, easy to carry and position to allow a higher cylinder capacity-to-weight-ratio**
- **Non-corrosive by design, aluminium has always been a good material for use in many caustic environments**
- **Composite Bearings on all moving surfaces guarantee no metal-to-metal contact, to resist side loads and increase cylinder life.**



RA Series

Capacity:
20 - 150 ton

Stroke:
50 - 250 mm

Maximum Operating Pressure:
700 bar



Think Safety

Manufacturer's rating of load and stroke are maximum safe limits.

Good practice encourages using only 80% of these ratings.

Page: 260



Aluminium versus Steel

Aluminium cylinders, while offering the most lightweight solution, also have some unique limitations due to material properties. It differs from steel in that it has a lower finite fatigue life. Aluminium cylinders should NOT be used in high-cycle applications such as production.

The Enerpac line of aluminium cylinders are designed to provide 5000 cycles at their recommended pressure. **This limit should not be exceeded.** In normal lifting and many maintenance applications, this should provide a lifetime of use.



Steel Base Plate

The steel base plate protects the cylinder from damage, it should not be removed.

The base holes in these aluminium cylinders are designed for securing the steel base plate. **They will not withstand the capacity of the cylinder.** Do not use the base holes in these aluminium cylinders to attach any device to the cylinder.

RAC-Series, Aluminium Cylinders

▼ Shown from left to right: RAC-5010, RAC-15010, RAC-304, RAC-208



Lightweight for Maximum Portability



Saddles

All RAC-cylinders are equipped with bolt-on removable hardened steel saddles. For Tilt Saddles see next page.

Page:  13



Lightweight Hand Pumps

The Enerpac composite lightweight hand pumps P-392 or P-802 make the optimal lightweight set.

Page:  64

- Composite bearings prevent metal-to-metal contact, increasing cylinder life and resistance to side-loads of up to 10%
- Hard-Coat finish on all surfaces resists damage and extends cylinder life
- Handles included on all models
- Steel base plate and saddle for protection against load-induced damage
- Integral stop ring prevents plunger over-travel and is capable of withstanding the full cylinder capacity
- High strength return spring for rapid cylinder retraction
- CR-400 coupler and dustcap included on all models
- All cylinders meet ASME B-30.1 and ISO 10100 standards.

Cylinder Capacity @ 700 bar ton (kN)	Stroke (mm)	Model Number	Cylinder Effective Area (cm ²)
20 (218)	50	RAC-202	31,2
	100	RAC-204	31,2
	150	RAC-206	31,2
	200	RAC-208	31,2
	250	RAC-2010	31,2
30 (309)	50	RAC-302	44,2
	100	RAC-304	44,2
	150	RAC-306	44,2
	200	RAC-308	44,2
	250	RAC-3010	44,2
50 (496)	50	RAC-502	70,9
	100	RAC-504	70,9
	150	RAC-506	70,9
	200	RAC-508	70,9
	250	RAC-5010	70,9
100 (1002)	50	RAC-1002	143,1
	100	RAC-1004	143,1
	150	RAC-1006	143,1
	200	RAC-1008	143,1
	250	RAC-10010	143,1
150 (1589)	50	RAC-1502	227,0
	100	RAC-1504	227,0
	150	RAC-1506	227,0
	200	RAC-1508	227,0
	250	RAC-15010	227,0



◀ The unique Enerpac RA-Series cylinders – lightweight and made of aluminium alloy – these RAC-506 cylinders are ideal for the positioning of tunnel elements under the river. (High Speed Train Line, The Netherlands)

Single-Acting, Aluminium Cylinders

Optional Bolt-on Tilt Saddle Dimensions (mm)			
For Cylinder Model / Capacity ton	Tilt Saddle * Model Number	Tilt Saddle Diameter J1	Saddle Protrusion from Plunger K1
RAC-50	CATG-50	50	24
RAC-100	CATG-150	91	31
RAC-150	CATG-200	118	35

* Tilt saddles not available for less than 50 ton.

RAC Series



Capacity:

20 - 150 ton

Stroke:

50 - 250 mm

Maximum Operating Pressure:

700 bar

Steel Base Plate Mounting Holes			
Cylinder Model / Capacity ton	Bolt Circle U (mm)	Thread V (mm)	Thread Depth ¹⁾ Z (mm)
RAC-20	70	M6	12
RAC-30	80	M6	12
RAC-50	110	M6	12
RAC-100	150	M10	12
RAC-150	200	M10	12

¹⁾ Including Base Plate Height of 6 mm and four (4) base plate bolts M6.

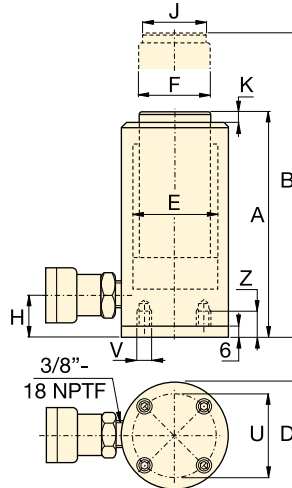

Oil Capacity (cm ³)	Collapsed Height A (mm)	Extended Height B (mm)	Outside Diameter D (mm)	Cylinder Bore Diameter E (mm)	Plunger Diameter F (mm)	Bottom to Advance Port H (mm)	Saddle Diameter J (mm)	Saddle Protrusion from Plunger K (mm)	Weight (kg)	Model Number
156	174	224	85	63	50	27	40	3	3,6	RAC-202
312	224	324	85	63	50	27	40	3	4,1	RAC-204
468	274	424	85	63	50	27	40	3	4,6	RAC-206
624	324	524	85	63	50	27	40	3	5,1	RAC-208
780	374	624	85	63	50	27	40	3	5,6	RAC-2010
221	181	231	100	75	60	32	40	3	4,5	RAC-302
442	231	331	100	75	60	32	40	3	5,2	RAC-304
663	281	431	100	75	60	32	40	3	5,9	RAC-306
884	331	531	100	75	60	32	40	3	6,6	RAC-308
1105	381	631	100	75	60	32	40	3	7,3	RAC-3010
354	186	236	130	95	80	30	50	3	8,5	RAC-502
709	236	336	130	95	80	30	50	3	9,8	RAC-504
1063	286	436	130	95	80	30	50	3	11,1	RAC-506
1417	336	536	130	95	80	30	50	3	12,4	RAC-508
1771	386	636	130	95	80	30	50	3	13,7	RAC-5010
715	221	271	180	135	110	46	94	3	17,3	RAC-1002
1431	271	371	180	135	110	46	94	3	19,6	RAC-1004
2147	321	471	180	135	110	46	94	3	21,9	RAC-1006
2863	371	571	180	135	110	46	94	3	24,2	RAC-1008
3578	421	671	180	135	110	46	94	3	26,5	RAC-10010
1135	243	293	230	170	140	51	113	3	25,3	RAC-1502
2270	293	393	230	170	140	51	113	3	29,3	RAC-1504
3405	343	493	230	170	140	51	113	3	33,3	RAC-1506
4540	393	593	230	170	140	51	113	3	37,3	RAC-1508
5675	443	693	230	170	140	51	113	3	41,3	RAC-15010

RACL-Series, Aluminium Lock Nut Cylinders

▼ Shown from left to right: RACL-1006, RACL-504, RACL-5010



- Aluminium Lock Nut provides mechanical load holding for extended periods
- Hardened steel stop ring increasing cylinder life and resistance to side-loads of up to 5%
- Hard-Coat finish on all surfaces resists damage and extends cylinder life
- Composite bearings increase cylinder life and side load resistance
- Handles included on all models
- Steel base plate and saddle for protection against load-induced damage
- Integral stop ring prevents plunger over-travel and is capable of withstanding the full cylinder capacity
- High strength return spring for rapid cylinder retraction
- CR-400 coupler and dustcap included on all models
- All cylinders meet ASME B-30.1 and ISO 10100 standards.



◀ The portable lock nut cylinder RACL-1506 used for extended load supports during epoxy injection for bridge reinforcement.



Saddles

All RACL-cylinders are equipped with bolt-on removable hardened steel saddles. For Tilt Saddles see next page.

Page: 15



Hoses

Enerpac offers a complete line of high quality hydraulic hoses. To ensure the integrity of your system, specify only Enerpac hydraulic hoses.

Page: 116

Cylinder Capacity @ 700 bar ton (kN)	Stroke (mm)	Model Number	Cylinder Effective Area (cm ²)
20 (218)	50	RACL-202	31,2
	100	RACL-204	31,2
	150	RACL-206	31,2
	200	RACL-208	31,2
	250	RACL-2010	31,2
30 (309)	50	RACL-302	44,2
	100	RACL-304	44,2
	150	RACL-306	44,2
	200	RACL-308	44,2
	250	RACL-3010	44,2
50 (496)	50	RACL-502	70,9
	100	RACL-504	70,9
	150	RACL-506	70,9
	200	RACL-508	70,9
	250	RACL-5010	70,9
100 (1002)	50	RACL-1002	143,1
	100	RACL-1004	143,1
	150	RACL-1006	143,1
	200	RACL-1008	143,1
	250	RACL-10010	143,1
150 (1589)	50	RACL-1502	227,0
	100	RACL-1504	227,0
	150	RACL-1506	227,0
	200	RACL-1508	227,0
	250	RACL-15010	227,0

Single-Acting, Aluminium Lock Nut Cylinders

Optional Bolt-on Tilt Saddle Dimensions (mm)				
For Cylinder Model / Capacity ton	Tilt Saddle * Model Number	Tilt Saddle Diameter J1	Saddle Protrusion from Plunger K1	
RACL-50	CATG-50	50	24	
RACL-100	CATG-150	91	31	
RACL-150	CATG-200	118	35	

* Tilt saddles not available for less than 50 ton.

Steel Base Plate Mounting Holes			
Cylinder Model / Capacity ton	Bolt Circle U (mm)	Thread V (mm)	Thread Depth ¹⁾ Z (mm)
RACL-20	70	M6	12
RACL-30	80	M6	12
RACL-50	110	M6	12
RACL-100	150	M10	12
RACL-150	200	M10	12

¹⁾ Including Base Plate Height of 6 mm and four (4) base plate bolts M6.

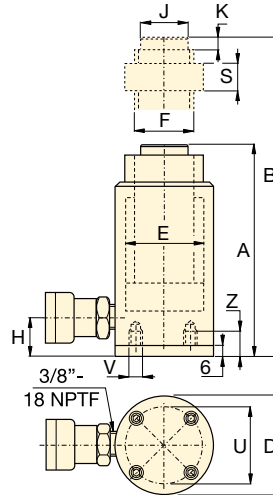

RACL Series



Capacity:

20 - 150 ton

Stroke:

50 - 250 mm

Maximum Operating Pressure:

700 bar

Oil Capacity (cm ³)	Collapsed Height A (mm)	Extended Height B (mm)	Outside Diameter D (mm)	Cylinder Bore Diameter E (mm)	Plunger Diameter (Threaded) F (mm)	Bottom to Advance Port H (mm)	Saddle Diameter J (mm)	Saddle Protrusion from Plunger K (mm)	Lock Nut Height S (mm)	Weight (kg)	Model Number
156	224	274	85	63	Tr 55 x 4	27	40	3	50	4,0	RACL-202
312	274	374	85	63	Tr 55 x 4	27	40	3	50	4,6	RACL-204
468	324	474	85	63	Tr 55 x 4	27	40	3	50	5,2	RACL-206
624	374	574	85	63	Tr 55 x 4	27	40	3	50	5,8	RACL-208
780	424	674	85	63	Tr 55 x 4	27	40	3	50	6,4	RACL-2010
221	231	281	100	75	Tr 60 x 4	33	40	3	50	5,4	RACL-302
442	281	381	100	75	Tr 60 x 4	33	40	3	50	6,1	RACL-304
663	331	481	100	75	Tr 60 x 4	33	40	3	50	6,8	RACL-306
883	381	581	100	75	Tr 60 x 4	33	40	3	50	7,5	RACL-308
1105	431	681	100	75	Tr 60 x 4	33	40	3	50	8,2	RACL-3010
354	236	286	130	95	Tr 80 x 4	30	50	3	50	9,3	RACL-502
709	286	386	130	95	Tr 80 x 4	30	50	3	50	10,6	RACL-504
1063	336	486	130	95	Tr 80 x 4	30	50	3	50	11,9	RACL-506
1417	386	586	130	95	Tr 80 x 4	30	50	3	50	13,2	RACL-508
1771	436	686	130	95	Tr 80 x 4	30	50	3	50	14,5	RACL-5010
716	296	346	180	135	Tr 110 x 6	46	94	3	75	21,9	RACL-1002
1431	346	446	180	135	Tr 110 x 6	46	94	3	75	24,2	RACL-1004
2147	396	546	180	135	Tr 110 x 6	46	94	3	75	26,5	RACL-1006
2863	446	646	180	135	Tr 110 x 6	46	94	3	75	28,8	RACL-1008
3578	496	746	180	135	Tr 110 x 6	46	94	3	75	31,1	RACL-10010
1135	323	373	230	170	Tr 140 x 6	51	113	3	80	32,2	RACL-1502
2270	373	473	230	170	Tr 140 x 6	51	113	3	80	36,2	RACL-1504
3405	423	573	230	170	Tr 140 x 6	51	113	3	80	40,2	RACL-1506
4540	473	673	230	170	Tr 140 x 6	51	113	3	80	44,2	RACL-1508
5675	523	773	230	170	Tr 140 x 6	51	113	3	80	48,2	RACL-15010

▼ Shown from left to right: RACH-1504, RACH-15010, RACH-206, RACH-306



The Lightweight Solution for Tensioning and Testing



Saddles

All RACH-cylinders are equipped with bolt-on hollow removable saddles of hardened steel.



Lightweight Hand Pumps

The Enerpac composite lightweight hand pumps P-392 or P-802 make the optimal lightweight set.

Page: 62

- Hollow plunger design allows for both pull and push forces
- Composite bearings increase cylinder life and sideload resistance
- Hard-Coat finish on all surfaces resists damage and extends cylinder life
- Floating center tube increases seal and product life
- Handles standard on all models
- Steel base plate and saddle for protection against load-induced damage
- Integral stop ring prevents plunger over-travel and is capable of withstanding the full cylinder capacity
- High strength return spring for rapid cylinder retraction
- CR-400 coupler and dustcap included on all models
- All cylinders meet ASME B-30.1 and ISO 10100 standards.



◀ An RACH-306 powered by a P-392 hand pump used to extract corroded carriage pins of refuse collection vehicles.

Cylinder Capacity @ 700 bar	Stroke	Model Number	Cylinder Effective Area
ton (kN)	(mm)		(cm ²)
20 (229)	50	RACH-202	32,7
	100	RACH-204	32,7
	150	RACH-206	32,7
	200	RACH-208	32,7
	250	RACH-2010	32,7
30 (358)	50	RACH-302	51,1
	100	RACH-304	51,1
	150	RACH-306	51,1
	200	RACH-308	51,1
	250	RACH-3010	51,1
60 (596)	50	RACH-602	84,7
	100	RACH-604	84,7
	150	RACH-606	84,7
	200	RACH-608	84,7
	250	RACH-6010	84,7
100 (1157)	50	RACH-1002	164,6
	100	RACH-1004	164,6
	150	RACH-1006	164,6
	200	RACH-1008	164,6
	250	RACH-10010	164,6
150 (1588)	50	RACH-1502	225,8
	100	RACH-1504	225,8
	150	RACH-1506	225,8
	200	RACH-1508	225,8
	250	RACH-15010	225,8

Single-Acting, Aluminium Hollow Plunger Cylinders

Steel Base Plate Mounting Holes

Cylinder Model / Capacity ton	Bolt Circle U (mm)	Thread V (mm)	Thread Depth ¹⁾ Z (mm)
RACH-20	80	M6	12
RACH-30	110	M6	12
RACH-60	160	M6	12
RACH-100	220	M10	12
RACH-150	245	M10	12

¹⁾ Including Base Plate Height of 6 mm and four (4) base plate bolts M6.

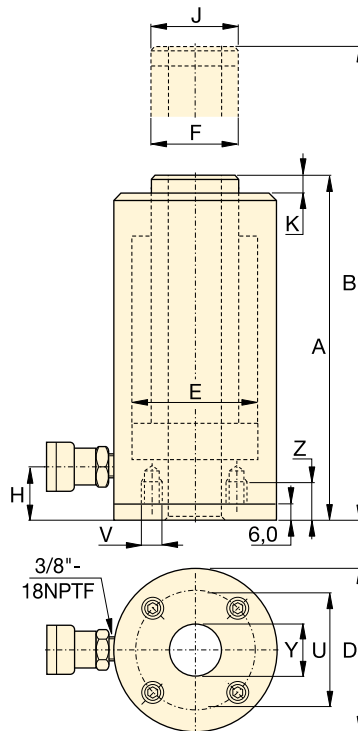

RACH Series

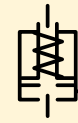

Capacity:

20 - 150 ton

Stroke:

50 - 250 mm

Center Hole Diameter:

27 - 79 mm

Maximum Operating Pressure:

700 bar

Oil Capacity (cm ³)	Collapsed Height A (mm)	Extended Height B (mm)	Outside Diameter D (mm)	Cylinder Bore Diameter E (mm)	Plunger Diameter F (mm)	Bottom to Advance Port H (mm)	Saddle Diameter J (mm)	Saddle Protrusion from Plunger K (mm)	Center Hole Diameter Y (mm)	Weight (kg)	Model Number
164	188	238	100	75	55	29	55	10	27	5,2	RACH-202
327	251	351	100	75	55	29	55	10	27	6,1	RACH-204
491	315	465	100	75	55	29	55	10	27	7,1	RACH-206
654	378	578	100	75	55	29	55	10	27	8,0	RACH-208
818	442	692	100	75	55	29	55	10	27	9,0	RACH-2010
256	208	258	130	95	70	29	70	10	34	8,0	RACH-302
511	267	367	130	95	70	29	70	10	34	9,5	RACH-304
766	333	483	130	95	70	29	70	10	34	11,2	RACH-306
1022	395	595	130	95	70	29	70	10	34	12,9	RACH-308
1277	458	708	130	95	70	29	70	10	34	14,5	RACH-3010
423	251	301	180	130	100	61	100	12	54	16,2	RACH-602
847	315	415	180	130	100	61	100	12	54	19,5	RACH-604
1270	380	530	180	130	100	61	100	12	54	25,6	RACH-606
1694	445	645	180	130	100	61	100	12	54	26,0	RACH-608
2117	510	760	180	130	100	61	100	12	54	29,6	RACH-6010
823	258	308	250	185	145	61	145	14	79	33,8	RACH-1002
1646	325	425	250	185	145	61	145	14	79	39,8	RACH-1004
2487	391	541	250	185	145	61	145	14	79	46,2	RACH-1006
3291	459	659	250	185	145	61	145	14	79	52,2	RACH-1008
4114	527	777	250	185	145	61	145	14	79	58,8	RACH-10010
1129	280	330	275	205	150	61	145	14	79	48,9	RACH-1502
2258	360	460	275	205	150	61	145	14	79	55,7	RACH-1504
3387	430	580	275	205	150	61	145	14	79	63,0	RACH-1506
4517	500	700	275	205	150	61	145	14	79	70,1	RACH-1508
5646	570	820	275	205	150	61	145	14	79	77,2	RACH-15010

RAR, Double-Acting, Aluminium Cylinders

▼ Shown from left to right: RAR-5010, RAR-308, RAR-204



Saddles

All RAR-cylinders are equipped with bolt-on removable hardened steel saddles.

For Tilt Saddles see next page.

Page: **19**



Hoses

Enerpac offers a complete line of high quality hydraulic hoses. To ensure the integrity of your system, specify only Enerpac hydraulic hoses.

Page: **116**

- Double-acting for rapid retraction, regardless of hose lengths or system losses
- Composite bearings increase cylinder life and sideload resistance
- Hard-Coat finish on all surfaces resists damage and extends cylinder life
- Handles included on all models
- Steel base plate and saddle for protection against load-induced damage
- Integral stop ring prevents plunger over-travel and is capable of withstanding the full cylinder capacity
- Built-in safety valve prevents accidental over-pressurization.

▼ An RAR-506 was easy to position under a bulldozer for repair of frame member.



Cylinder Capacity @ 700 bar ton	Stroke (mm)	Model Number	Max. Cylinder Capacity (kN)		Cylinder Effective Area (cm ²)		Oil Capacity (cm ³)	
			Push	Pull	Push	Pull	Push	Pull
20	50	RAR-202	218	130	31,2	18,6	156	93
	100	RAR-204	218	130	31,2	18,6	312	186
	150	RAR-206	218	130	31,2	18,6	468	279
	200	RAR-208	218	130	31,2	18,6	624	372
	250	RAR-2010	218	130	31,2	18,6	780	465
30	50	RAR-302	309	179	44,2	24,5	221	123
	100	RAR-304	309	179	44,2	24,5	442	245
	150	RAR-306	309	179	44,2	24,5	663	368
	200	RAR-308	309	179	44,2	24,5	884	490
	250	RAR-3010	309	179	44,2	24,5	1105	613
50	50	RAR-502	496	187	70,9	26,7	354	134
	100	RAR-504	496	187	70,9	26,7	709	267
	150	RAR-506	496	187	70,9	26,7	1063	401
	200	RAR-508	496	187	70,9	26,7	1417	534
	250	RAR-5010	496	187	70,9	26,7	1771	668
100	50	RAR-1002	1002	557	143,1	79,5	715	398
	100	RAR-1004	1002	557	143,1	79,5	1431	795
	150	RAR-1006	1002	557	143,1	79,5	2147	1193
	200	RAR-1008	1002	557	143,1	79,5	2863	1590
	250	RAR-10010	1002	557	143,1	79,5	3578	1988
150	50	RAR-1502	1589	924	227,0	132,0	1135	660
	100	RAR-1504	1589	924	227,0	132,0	2270	1320
	150	RAR-1506	1589	924	227,0	132,0	3405	1980
	200	RAR-1508	1589	924	227,0	132,0	4540	2640
	250	RAR-15010	1589	924	227,0	132,0	5675	3300

Double-Acting, Aluminium Cylinders

Optional Bolt-on Tilt Saddle Dimensions (mm)			
For Cylinder Model / Capacity ton	Tilt Saddle * Model Number	Tilt Saddle Diameter J1	Saddle Protrusion from Plunger K1
RAR-50	CATG-50	50	24
RAR-100	CATG-100	73	29
RAR-150	CATG-150	91	31

* Tilt saddles not available for less than 50 ton.

RAR Series



Capacity:
20 - 150 ton

Stroke:
50 - 250 mm

Maximum Operating Pressure:
700 bar

Steel Base Plate Mounting Holes			
Cylinder Model / Capacity ton	Bolt Circle U (mm)	Thread V (mm)	Thread Depth ¹⁾ Z (mm)
RAR-20	93	M6	12
RAR-30	105	M6	12
RAR-50	110	M6	12
RAR-100	165	M6	12
RAR-150	200	M6	12

¹⁾ Including Base Plate Height of 6 mm and four (4) base plate bolts M6.

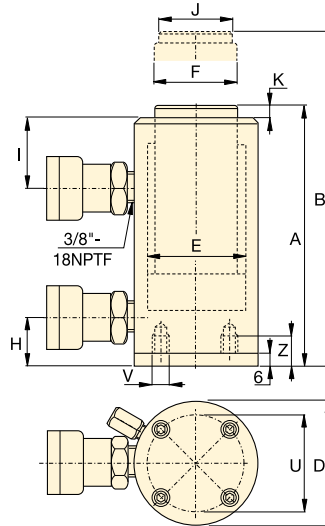

Collapsed Height A (mm)	Extended Height B (mm)	Outside Diameter D (mm)	Cylinder Bore Diameter E (mm)	Plunger Diameter F (mm)	Bottom to Advance Port H (mm)	Top to Retract Port I (mm)	Saddle Diameter J (mm)	Saddle Protrusion from Plunger K (mm)	(kg)	Model Number
189	239	113	63	40	30	50	30	3	7,4	RAR-202
239	339	113	63	40	30	50	30	3	8,0	RAR-204
289	439	113	63	40	30	50	30	3	8,6	RAR-206
339	539	113	63	40	30	50	30	3	9,2	RAR-208
389	639	113	63	40	30	50	30	3	9,8	RAR-2010
201	251	125	75	50	30	55	40	3	8,6	RAR-302
251	351	125	75	50	30	55	40	3	9,5	RAR-304
301	451	125	75	50	30	55	40	3	10,4	RAR-306
351	551	125	75	50	30	55	40	3	11,3	RAR-308
401	651	125	75	50	30	55	40	3	12,2	RAR-3010
201	251	145	95	75	30	56	50	3	11,1	RAR-502
251	351	145	95	75	30	56	50	3	12,7	RAR-504
301	451	145	95	75	30	56	50	3	14,3	RAR-506
351	551	145	95	75	30	56	50	3	15,9	RAR-508
401	651	145	95	75	30	56	50	3	17,5	RAR-5010
251	301	185	135	90	43	80	75	3	16,4	RAR-1002
301	401	185	135	90	43	80	75	3	19,3	RAR-1004
351	501	185	135	90	43	80	75	3	22,2	RAR-1006
401	601	185	135	90	43	80	75	3	25,1	RAR-1008
451	701	185	135	90	43	80	75	3	28,0	RAR-10010
248	298	230	170	110	38	75	113	3	24,2	RAR-1502
298	398	230	170	110	38	75	113	3	28,9	RAR-1504
348	498	230	170	110	38	75	113	3	33,2	RAR-1506
398	598	230	170	110	38	75	113	3	37,9	RAR-1508
448	698	230	170	110	38	75	113	3	42,6	RAR-15010

▼ LPL-Series, Low Height Lock Nut Cylinders



- Lock nut provide mechanical load holding for a safe work environment
- Integrated tilt saddle allows for up to 5 degrees of misalignment
- Extreme low height for use in confined areas
- Side-load resistance 5-10% of maximum capacity
- Overflow port as stroke limiter to prevent plunger blow-out
- Single-acting, gravity return.

▼ Only the extreme low height LPL-cylinder fits in this confined area to lift the construction. The lock nut provides positive and safe mechanical load holding over a long period of time.



Integrated Tilt Saddles

All LPL-Series cylinders include integral tilt saddles with maximum tilt angles up to 5°.



The Summit Edition

Innovation is at the heart of the new Summit Edition of cylinders, delivering the high quality construction that you expect from Enerpac. The durability ensures your job gets done safely and reliably.

- Replaceable plunger support bearing adds support for eccentric loads *
- Nitrocarburization surface treatment for improved load and wear resistance and corrosion protection
- Low wear, high pressure seals provide longer service life.

* Eccentric load (or "side-load") is inevitable in heavy lifting. Our unique Summit Edition features provide the ultimate protection against side load. Increased bearing surface maintains stability and nitrocarburization treatment prevents scoring on the inside of the cylinder. Side-load poses a real problem.... our new cylinder features are the solution!

Cylinder Capacity	Stroke	Model Number	Maximum Cylinder Capacity at 700 bar ton (kN)	Side-load Resistance of Maximum Capacity	Cylinder Effective Area
ton	(mm)				(cm ²)
60	50	LPL-602	62 (606)	10%	86,6
100	50	LPL-1002	102 (1002)	10%	143,1
150	45	LPL-1602	162 (1589)	8%	227,0
200	45	LPL-2002	202 (1985)	8%	283,5
250	45	LPL-2502	259 (2541)	5%	363,1
400	45	LPL-4002	409 (4008)	5%	572,6
500	45	LPL-5002	522 (5114)	5%	730,6

Single-Acting, Low Height Lock Nut Cylinders



IMPORTANT!

All LPL-Series cylinders require a solid lifting surface for correct support. The use of these cylinders on surfaces such as sand, mud or dirt, may result in cylinder damage.

WRONG!

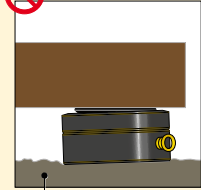

Rough soil

RIGHT!

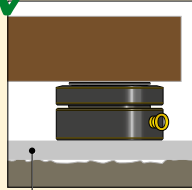

Flat lifting surface

For more safety instructions see our 'Learning Center' on www.enerpac.com

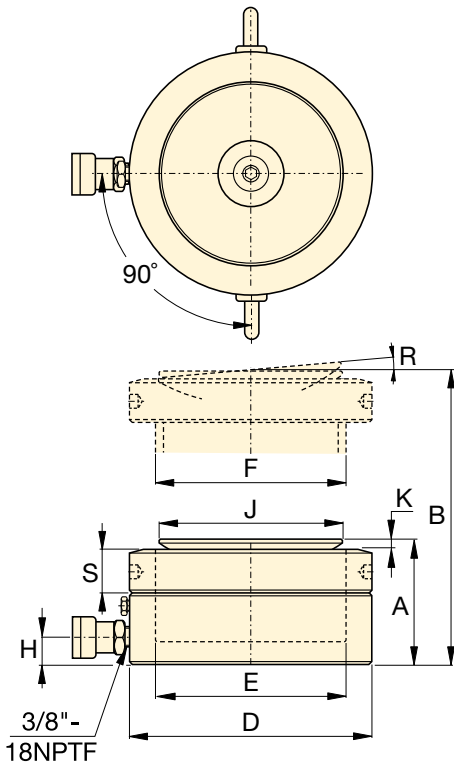

LPL Series



Capacity:

60 - 500 ton

Stroke:

45 - 50 mm

Maximum Operating Pressure:

700 bar



Longer Stroke Lock Nut Cylinders

For longer stroke applications **HCL-Series** lock nut cylinders are the perfect choice.

Page: 48



Split-Flow Pumps

SFP-Series Pumps with multiple outlets with equal oil flow. For lifting and lowering applications on multiple points these pumps are a far better alternative than using separately operated pumps.

Page: 236



Synchronous Lifting Systems

Pumps for multiple lift point capabilities. The economical **EVOB-Series** for basic applications and the multi-functional **EVO-Series** lifting system.

Page: 238

Oil Capacity	Collapsed Height	Extended Height	Outside Diameter	Cylinder Bore Diameter	Plunger Diameter	Base to Advance Port	Saddle Diameter	Saddle Protrusion from Plgr.	Saddle Max. Tilt Angle	Lock Nut Height		Model Number
(cm ³)	A (mm)	B (mm)	D (mm)	E (mm)	F (mm)	H (mm)	J (mm)	K (mm)	R	S (mm)	(kg)	
433,0	126	176	140	105	Tr 105 x 4	19	96	7	5°	28	15	LPL-602
715,7	137	187	173	135	Tr 135 x 6	21	126	8	5°	31	25	LPL-1002
1021,4	148	193	220	170	Tr 170 x 6	27	160	9	5°	40	43	LPL-1602
1275,9	155	200	245	190	Tr 190 x 6	30	180	10	5°	43	55	LPL-2002
1633,7	159	204	275	215	Tr 215 x 6	32	200	12	5°	43	70	LPL-2502
2576,5	178	223	350	270	Tr 270 x 6	40	250	12	4°	55	129	LPL-4002
3287,8	192	237	400	305	Tr 305 x 6	49	290	10	3°	61,5	183	LPL-5002

▼ Shown from left to right: RSM-1000, RSM-300, RSM-50, RCS-1002, RCS-302



Maximum Power-to-Height Ratio



Saddles

All RCS-Series cylinders have plunger mounting holes for installation of tilt saddles. See table for selection and dimensional information.

Page: **23**



Low Clearance Lifting

The LW-16 Lifting Wedge and SOH-Series Machine Lifts are the perfect choice for lifting the first few millimeters.

Page: **166**

RSM-series, Flat-Jac® Cylinders

- Compact, flat design for use where most other cylinders will not fit
- Single-acting, spring return
- RSM-750, 1000 and 1500 have handles for easy carrying
- Mounting holes permit easy fixturing
- Baked enamel finish for increased corrosion resistance
- CR-400 coupler and dust cap included on all models¹⁾
- Hard chrome plated high quality steel plungers
- Grooved plunger ends require no saddle.

RCS-series, Low Height Cylinders

- Lightweight, low profile design for use in confined spaces
- Single-acting, spring return
- Baked enamel finish for increased corrosion resistance
- Plunger wiper reduces contamination, extending cylinder life
- CR-400 coupler and dust cap included on all models
- Grooved plunger end with threaded holes for mounting tilt saddles
- Integral handle on RCS-1002 for easy carrying
- Plated steel plungers.

▼ Only a couple of centimeters will do for an RSM-cylinder to lift a large construction.

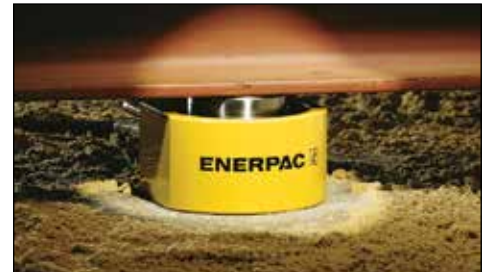

Cyl. Capacity	Stroke	Model Number	Cylinder Effective Area	Oil Capacity
ton (kN)	(mm)		(cm ²)	(cm ³)
5 (45)	6	RSM-50 ¹⁾	6,5	4
10 (101)	11	RSM-100 *	14,5	18
20 (201)	11	RSM-200 *	28,7	32
30 (295)	13	RSM-300 *	42,1	55
45 (435)	16	RSM-500 *	62,1	99
75 (718)	16	RSM-750	102,6	164
90 (887)	16	RSM-1000	126,7	203
150 (1386)	16	RSM-1500	198,1	317
10 (101)	38	RCS-101 *	14,5	55
20 (201)	45	RCS-201 *	28,7	129
30 (295)	62	RCS-302 *	42,1	261
45 (435)	60	RCS-502 *	62,1	373
90 (887)	57	RCS-1002 *	126,7	722

¹⁾ RSM-50 is fitted with an AR-400 coupler.

* Available as set, see note on next page.

Single-Acting, Low Height Cylinders

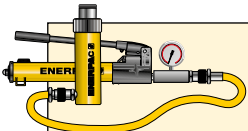

Cylinder-Pump Sets

All cylinders marked with an * are available as (cylinder, gauge, couplers, hose and pump) for your ordering convenience.

Page: **52**

RSM, RCS Series



Capacity:

5 - 150 ton

Stroke:

6 - 62 mm

Maximum Operating Pressure:

700 bar

Optional Bolt On Tilt Saddle Dimensions (mm)

For Cylinder Model:	Model Number	A	B	C*
RCS-101	CAT-11	35	11	21
RCS-201, -302, -502	CAT-51	50	15	29
RCS-1002	CAT-101	71	17	35

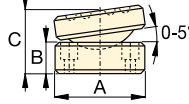

* 'C' dimension equals saddle protrusion from plunger. Mounting screws are included.

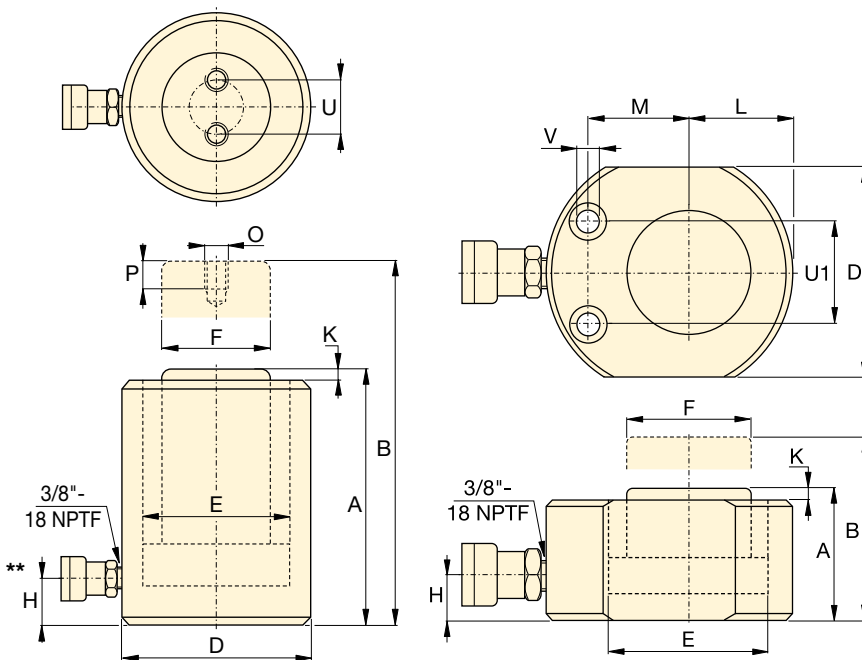

RCS-Series

RSM-Series



Power Box

Tool box with hand pump, gauge adaptor assembly, hose and RSM or RCS-cylinders.

Page: **55**

RSM Cylinder Mounting Hole Dimensions (mm)

Model Number	Bolt Circle U1	Hole Dia. V	Counter Bore Dia.	Counter Bore Depth
RSM-50	28,5	5,5	9,1	4,3
RSM-100	36,6	7,1	10,7	7,9
RSM-200	49,3	10,0	15,1	9,9
RSM-300	52,3	10,0	15,9	11,2
RSM-500	66,5	11,0	19,0	12,7
RSM-750	76,2	13,5	20,6	14,2
RSM-1000	76,2	13,5	20,6	14,2
RSM-1500	117,3	13,5	20,6	14,2

Collapsed Height	Extended Height	Outside Diameter	Cylinder Bore Dia.	Plunger Dia.	Base to Advance Port	Plunger Protrusion from Base	Plunger to Base	Plunger to Mtg. Hole	Thread	Thread Depth	Bolt Circle	Weight	Model Number
A (mm)	B (mm)	D (mm)	E (mm)	F (mm)	H (mm)	K (mm)	L (mm)	M (mm)	O (mm)	P (mm)	U (mm)	(kg)	
32	38	58 x 41	28,7	25,4	16	1	20	22	-	-	-	1,0	RSM-50 ¹⁾
43	54	82 x 55	42,9	38,1	19	1	27	34	-	-	-	1,4	RSM-100 *
51	62	101 x 76	60,5	50,8	19	1	39	39	-	-	-	3,1	RSM-200 *
58	71	117 x 95	73,2	63,4	19	2	47	44	-	-	-	4,5	RSM-300 *
66	82	140 x 114	88,9	69,8	19	2	57	53	-	-	-	6,8	RSM-500 *
79	95	165 x 139	114,3	82,6	19	2	69	66	-	-	-	11,3	RSM-750
85	101	178 x 153	127,0	92,2	19	2	76	74	-	-	-	14,5	RSM-1000
100	116	215 x 190	158,8	114,3	23	2	95	82	-	-	-	26,3	RSM-1500
88	126	69	42,9	38,1	17	5	-	-	M4	8	26	2,7	RCS-101 *
98	143	92	60,5	50,8	17	3	-	-	M5	8	40	5,0	RCS-201 *
117	179	101	73,2	66,5	19	3	-	-	M5	8	40	6,8	RCS-302 *
122	182	124	88,9	69,8	23	2	-	-	M5	8	40	10,0	RCS-502 *
141	198	165	127,0	92,2	31	1	-	-	M8	10	55	20,7	RCS-1002 *

** 5° angle position of coupler on RCS-101, 201, 302.

▼ Shown from left to right: BRC-25, BRC-46, BRP-306, BRP-606, BRP-106C



- High strength alloy steel construction
- Hard chrome-plated plunger for long life
- Replaceable links on BRP-models
- Baked enamel finish for increased corrosion resistance
- CR-400 coupler and dust cap included on all models
- Plunger wiper reduces contamination, extending cylinder life
- Single-acting, spring return.

▼ Ship building, welding and Enerpac pull cylinders go hand in hand.



The Ultimate in Pulling Power



Gauges

Minimize the risk of overloading and ensure long, dependable service from your equipment. Refer to the

System Components Section for a full range of gauges.

Page: 114



Attachments and Accessories

BRC-25 and BRC-46 units have base, collar and plunger threads to affix

a range of optional attachments and accessories, such as chains, saddles and extension tubes.

Page: 159

▼ To lift a load bearing mast into place, BRP-series cylinders were used to tension the supporting cables.



Single-Acting, Pull Cylinders

BRC Cylinder Mounting Dimensions (mm)				
Model Number	Base Mounting Hole V	Collar Thread W	Collar Thd. Lgth. X	Mtg. Thd. Lgth. Z
BRC-25	3/4"-14 NPT	1 1/2" - 16 UN	24	17
BRC-46	1 1/4"-11 1/2 NPT	2 1/4" - 14 UN	26	24
BRC-106	M30 x 2	M85 x 2	25	24

**BRC,
BRP
Series**



Capacity:
2,5 - 50 ton

Stroke:
127 - 154 mm

Maximum Operating Pressure:
700 bar

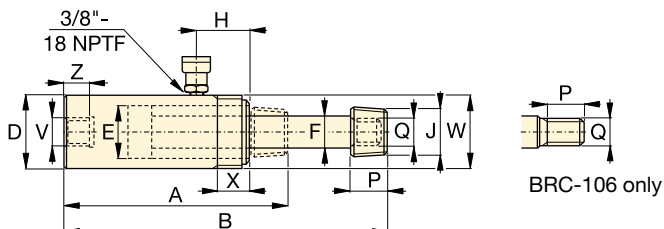

BRC-25, -46, 106

Cylinder Capacity	Stroke	Model Number	Cylinder Effective Area	Oil Capacity	Coll. Height	Ext. Height	Outside Dia.	Cylinder Bore Dia.	Plunger Dia.	Top to Inlet Port H	Saddle Diameter J (NPT)	Plunger Thread Length P (mm)	Plunger Outside Thread Q	(kg)
ton (kN)	(mm)		(cm ²)	(cm ³)	A (mm)	B (mm)	D (mm)	E (mm)	F (mm)	H (mm)	J (NPT)	P (mm)	Q	(kg)
2,5 (24)	127	BRC-25	3,5	45	264	391	48	28,4	19,0	45	3/4" - 14	28	1 1/16" - 24	1,8
5 (51)	140	BRC-46	7,3	101	301	441	57	42,9	30,2	42	1 1/4" - 11 1/2	32	1 3/16" - 16	4,5
10 (105)	151	BRC-106	15,0	228	289	440	85	54,1	31,8	39	-	25	M30x2	9,5

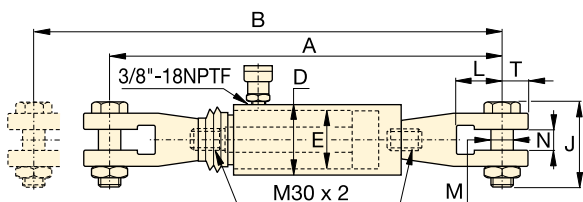

BRP-106C

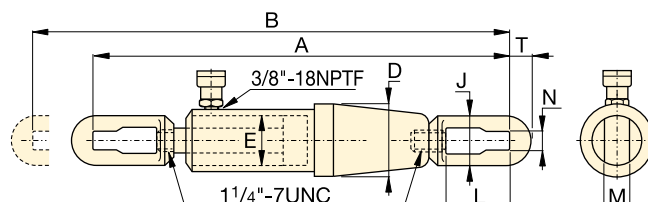

BRP-306

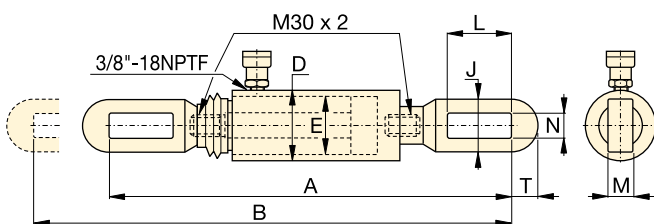

BRP-106L

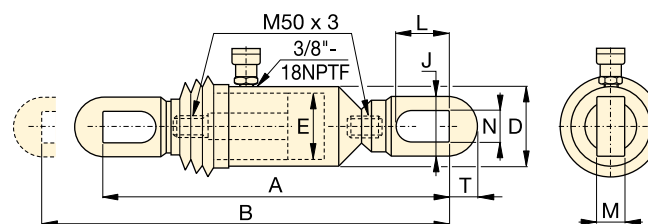

BRP-606

Cylinder Capacity	Stroke	Model Number	Cylinder Effective Area	Oil Capacity	Coll. Height	Ext. Height	Outside Dia.	Cyl. Bore Dia.	Link Height	Link Opening L	Link Thickness M	Link Width N	Slot to Link End T	(kg)
ton (kN)	(mm)		(cm ²)	(cm ³)	A (mm)	B (mm)	D (mm)	E (mm)	J (mm)	L (mm)	M (mm)	N (mm)	T (mm)	(kg)
10 (110)	150	BRP-106C	15,8	238	601	751	85	54,1	105	87	30	35	32	15,3
	150	BRP-106L	15,8	238	581	751	85	54,1	64	119	22	34	32	13,3
30 (325)	154	BRP-306	46,4	715	1110	1264	137	88,9	114	155	35	43	55	63,1
50 (506)	153	BRP-606	72,1	1096	718	871	140	110,1	130	151	40	48	65	58,3

▼ Shown from left to right: RCH-306, RCH-120, RCH-1003



- Hollow plunger design allows for both, pull and push forces
- Single-acting, spring return
- Nickel-plated, floating center tube on models over 20 ton increases product life
- Baked enamel finish for increased corrosion resistance
- Collar threads for easy fixturing
- RCH-120 includes AR-630 coupler and has 1/4" NPTF port
- RCH-121 and RCH-1211 have FZ-1630 reducer and AR-630 coupler, all other models feature CR-400 coupler.

▼ Hollow plunger cylinder RCH-1003 used in an application for intermediate boom suspension on a dragline.



Versatility in Testing, Maintenance and Tensioning Applications

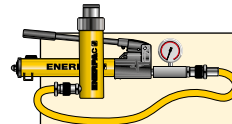

Cylinder-Pump Sets

All cylinders marked with an * are available as **sets** (cylinder, gauge, couplers, hose and pump) for your ordering convenience.

Page: **52**



Ultra-Lightweight Aluminium Cylinders

If you need a higher cylinder capacity-to-weight-ratio the lightweight **RACH-Series** are the perfect choice.

Page: **16**



Saddles

Most RCH-Series cylinders are equipped with smooth saddles. See table at next page for optional threaded saddles and all dimensional information.

Page: **27**

Cylinder Capacity	Stroke	Model Number	Cylinder Effective Area	Oil Capacity
ton (kN)	(mm)		(cm ²)	(cm ³)
13 (125)	8	RCH-120	17,9	14
	42	RCH-121*	17,9	75
	42	RCH-1211	17,9	75
	76	RCH-123	17,9	136
20 (215)	49	RCH-202*	30,7	150
	155	RCH-206	30,7	476
30 (326)	64	RCH-302*	46,6	298
	155	RCH-306	46,6	722
60 (576)	76	RCH-603*	82,3	626
	153	RCH-606	82,3	1259
95 (931)	76	RCH-1003*	133,0	1011

* Available as set, see note on this page.

Single-Acting, Hollow Plunger Cylinders



Hoses

Enerpac offers a complete line of high quality hydraulic hoses. To ensure the integrity of your system, specify only Enerpac hydraulic hoses.

Page: **116**

RCH Series

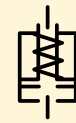

Capacity:

13-95 ton

Stroke:

8-155 mm

Center Hole Diameter:

17,3-79,0 mm

Maximum Operating Pressure:

700 bar

Optional Heat Treated Hollow Saddles

Saddle Type	Cylinder Model Number	Saddle Model Nr.	Saddle Dimensions (mm)		
			A	B	C
Threaded Hollow	RCH-202, 206	HP-2015	53	1" - 8	9
	RCH-302, 306	HP-3015	63	1 1/4" - 7	9
	RCH-603, 606	HP-5016	91	1 5/8" - 5 1/2	12
	RCH-1003	HP-10016	126	2 1/2" - 8	13

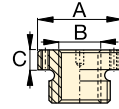

Smooth hollow saddles are standard on all RCH-models (except RCH-120, RCH-1211).

RCH-121 and RCH-1211 have a 47 mm dia. boss that protrudes 6 mm from base.

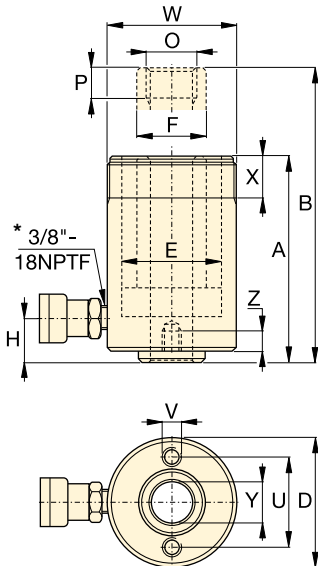

RCH-120 to RCH-123 models
* 1/4" NPTF for RCH-120 only

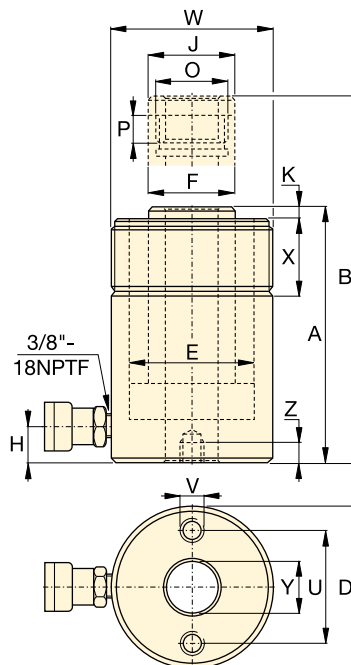

RCH-202 to RCH-1003 models

Base Mounting Hole Dimensions (mm)

Model Number	Bolt Circle U	Thread V	Thread Depth Z
RCH-120	50,8	5/16" - 18 UNC	9,0
RCH-121	-	-	-
RCH-1211	-	-	-
RCH-123	50,8	5/16" - 18 UNC	12,7
RCH-202	82,6	3/8" - 16 UNC	9,4
RCH-206	82,6	3/8" - 16 UNC	9,4
RCH-302	92,2	3/8" - 16 UNC	14,0
RCH-306	92,2	3/8" - 16 UNC	14,0
RCH-603	130,3	1/2" - 13 UNC	14,0
RCH-606	130,3	1/2" - 13 UNC	14,0
RCH-1003	177,8	5/8" - 11 UNC	19,0

Coll. Height A (mm)	Ext. Height B (mm)	Outside Dia. D (mm)	Cyl. Bore Dia. E (mm)	Plgr. Dia. F (mm)	Cyl. Base to Advance Port H (mm)	Saddle Dia. J (mm)	Saddle Protrusion from Plgr. K (mm)	Plunger Internal Thread O	Plunger Thread Length P (mm)	Collar Thread W	Collar Thread Length X (mm)	Center Hole Dia. Y (mm)	Weight (kg)	Model Number
55	63	69	54,1	35,1	9	-	-	3/4" - 16 UN	16	2 3/4" - 16	30	17,3	1,5	RCH-120
120	162	69	54,1	35,1	25	-	-	-	-	2 3/4" - 16	30	19,5	2,8	RCH-121*
120	162	69	54,1	35,1	25	-	-	3/4" - 16 UN	16	2 3/4" - 16	30	17,3	2,8	RCH-1211
184	260	69	54,1	35,1	25	-	-	-	-	2 3/4" - 16	30	19,5	4,4	RCH-123
162	211	98	73,1	54,1	19	54	9,7	1 9/16" - 16 UN	19	3 7/8" - 12	38	26,9	7,7	RCH-202*
306	461	98	73,1	54,1	25	54	9,7	1 9/16" - 16 UN	19	3 7/8" - 12	38	26,9	14,1	RCH-206
178	242	114	88,9	63,5	21	63	9,0	1 13/16" - 16 UN	22	4 1/2" - 12	42	33,3	10,9	RCH-302*
330	485	114	88,9	63,5	25	63	9,0	1 13/16" - 16 UN	22	4 1/2" - 12	42	33,3	21,8	RCH-306
247	323	159	123,9	91,9	31	91	12,0	2 3/4" - 16 UN	19	6 1/4" - 12	48	53,8	28,1	RCH-603*
323	476	159	123,9	91,9	31	91	12,0	2 3/4" - 16 UN	19	6 1/4" - 12	48	53,8	35,4	RCH-606
254	330	212	165,1	127,0	38	126	12,0	4" - 16 UN	25	8 3/8" - 12	60	79,0	63,0	RCH-1003*

▼ Shown from left to right: RRH-3010, RRH-1001, RRH-6010



- Relief valves prevent damage in case of over-pressurisation
- Baked enamel finish for increased corrosion resistance
- Collar threads enable easy fixturing (except RRH-1001 and RRH-1508)
- Double-acting version for fast retraction
- Nickel-plated, floating center tube increases product life
- Hollow plunger allows for both pull and push forces
- CR-400 coupler and dust cap included on all models
- Plunger wiper reduces contamination, extending cylinder life.

Versatility in Testing, Maintenance and Tensioning Applications



Pump Selection

A double-acting cylinder must be powered by a pump with a 4-way valve.

Page: 109



Gauges

Minimize the risk of overloading and ensure long, dependable service from your equipment. Refer to the System Components Section for a full range of gauges.

Page: 114



Saddles

All RRH-Series cylinders are equipped with smooth saddles. See table at next page for optional threaded saddles and all dimensional information.

Page: 29

▼ Double-acting hollow plunger cylinders are applied for bridge launching systems.



Cylinder Capacity ton	Stroke (mm)	Model Number	Max. Cylinder Capacity (kN)		Cylinder Effective Area (cm ²)		Oil Capacity (cm ³)	
			Advance	Retract	Advance	Retract	Advance	Retract
30	178	RRH-307	326	213	46,6	30,4	829	541
	258	RRH-3010	326	213	46,6	30,4	1202	784
60	89	RRH-603	576	380	82,3	54,2	733	482
	166	RRH-606	576	380	82,3	54,2	1366	900
	257	RRH-6010	576	380	82,3	54,2	2115	1393
95	38	RRH-1001	931	612	133,0	87,4	505	333
	76	RRH-1003	931	612	133,0	87,4	1011	666
	153	RRH-1006	931	612	133,0	87,4	2035	1337
	257	RRH-10010	931	612	133,0	87,4	3420	2246
145	203	RRH-1508	1429	718	204,1	102,6	4144	2083

Double-Acting, Hollow Plunger Cylinders



Hoses

Enerpac offers a complete line of high quality hydraulic hoses. To ensure the integrity of your system, specify only Enerpac hydraulic hoses.

Page: **116**

Optional Heat Treated Hollow Saddles						
Saddle Type	Cylinder Model Number	Saddle Model Nr.	Saddle Dimensions (mm)			
			A	B	C	
Threaded Hollow	RRH-307, 3010	HP-3015	63	1 1/4" - 7	9	
	RRH-603, 606, 6010	HP-5016	91	1 5/8" - 5 1/2	12	
	RRH-1001, 1003, RRH-1006, 10010	HP-10016	126	2 1/2" - 8	13	

Smooth hollow saddles are standard on all RRH-models.

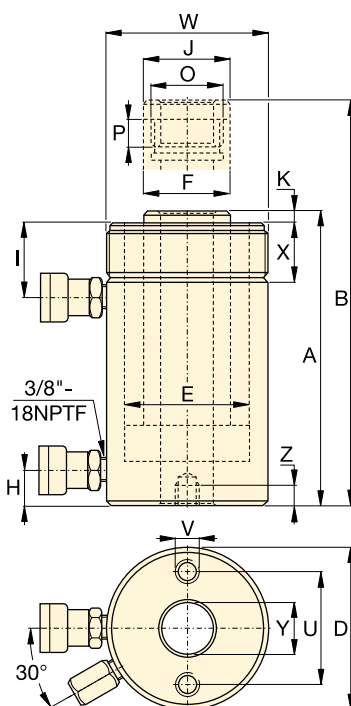

RRH Series



Capacity:

30 - 145 ton

Stroke:

38 - 258 mm

Center Hole Diameter:

33,3 - 79,2 mm

Maximum Operating Pressure:

700 bar

Base Mounting Hole Dimensions (mm)			
Model Number	Bolt Circle U	Thread V	Thread Depth Z
RRH-307	92,2	3/8" - 16	15,7
RRH-3010	92,2	3/8" - 16	15,7
RRH-603	130,0	1/2" - 13	14,0
RRH-606	130,0	1/2" - 13	14,0
RRH-6010	130,0	1/2" - 13	14,0
RRH-1001	177,8	5/8" - 11	19,0
RRH-1003	177,8	5/8" - 11	19,0
RRH-1006	177,8	5/8" - 11	19,0
RRH-10010	177,8	5/8" - 11	19,0
RRH-1508	-	-	-

Coll. Height A (mm)	Ext. Height B (mm)	Out. Dia. D (mm)	Cyl. Bore Dia. E (mm)	Plgr. Dia. F (mm)	Cyl. Base to Adv. Port H (mm)	Cyl. Top to Return Port I (mm)	Saddle Dia. J (mm)	Saddle Protr. fr. Plgr. K (mm)	Thread O	Plunger Thread Length P (mm)	Collar Thread W	Collar Thread Length X (mm)	Center Hole Dia. Y (mm)	(kg)	Model Number
330	508	114	88,9	63,5	25	60	63	9	1 13/16" - 16	22	4 1/2" - 12	42	33,3	21	RRH-307
431	689	114	88,9	63,5	25	60	63	9	1 13/16" - 16	22	4 1/2" - 12	42	33,3	27	RRH-3010
247	336	159	123,9	91,9	31	66	91	12	2 3/4" - 16	19	6 1/4" - 12	48	53,8	28	RRH-603
323	489	159	123,9	91,9	31	66	91	12	2 3/4" - 16	19	6 1/4" - 12	48	53,8	35	RRH-606
438	695	159	123,9	91,9	31	66	91	12	2 3/4" - 16	19	6 1/4" - 12	48	53,8	45	RRH-6010
165	203	212	165,1	127,0	38	44	126	12	4" - 16	25	-	-	79,2	33	RRH-1001
254	330	212	165,1	127,0	38	85	126	12	4" - 16	25	8 3/8" - 12	60	79,2	61	RRH-1003
342	495	212	165,1	127,0	38	85	126	12	4" - 16	25	8 3/8" - 12	60	79,2	79	RRH-1006
460	717	212	165,1	127,0	38	85	126	12	4" - 16	25	8 3/8" - 12	60	79,2	106	RRH-10010
349	552	247	190,5	152,4	38	60	127	4	4 1/4" - 12	25	-	-	79,2	111	RRH-1508

▼ Shown from left to right: BRD-2510, BRD-96, BRD-256, BRD-41, BRD-166



High Precision and High Cycle Performance



Speed Chart

See the Enerpac Cylinder Speed Chart in our 'Yellow Pages' to determine your approximate cylinder speed.

Page: 269

- Designed for long life, the best choice for production applications
- Unique mounting configurations simplify fixturing
- Baked enamel finish for increased corrosion resistance
- Double-acting operation develops force in both directions, providing maximum versatility
- Plunger wiper reduces contamination, extending cylinder life
- Imperial models (RD-series) available on request.

▼ Clamping application using Enerpac BRD cylinders (with clevis eye attachments on both ends) for their high pressure capability and mounting flexibility.



Cylinder Capacity (ton)	Stroke (mm)	Model Number	Max. Cylinder Capacity (kN)		Cylinder Effective Area (cm ²)		Oil Capacity (cm ³)		Coll. Height A (mm)	Extended Height B (mm)	Body Length C (mm)	Outside Dia. D (mm)	Cylinder Bore Dia. E (mm)	Plunger Dia. F (mm)
			Advance	Retract	Advance	Retract	Advance	Retract						
4	28	BRD-41	35	16	5,1	2,2	14	6	186	214	162	50	25,4	19,0
	79	BRD-43	35	16	5,1	2,2	40	17	237	316	213	50	25,4	19,0
	155	BRD-46	35	16	5,1	2,2	79	34	313	468	289	50	25,4	19,0
8	28	BRD-91	80	44	11,4	6,3	32	18	223	251	198	63,5	38,1	25,4
	79	BRD-93	80	44	11,4	6,3	90	50	274	353	249	63,5	38,1	25,4
	155	BRD-96	80	44	11,4	6,3	177	98	350	505	325	63,5	38,1	25,4
	257	BRD-910	80	44	11,4	6,3	293	162	452	709	427	63,5	38,1	25,4
15	159	BRD-166	142	77	20,3	10,6	323	169	389	548	359	80	50,8	35,0
	260	BRD-1610	142	77	20,3	10,6	528	276	491	751	461	80	50,8	35,0
23	159	BRD-256	222	98	31,7	13,7	504	218	424	583	397	92	63,5	47,8
	260	BRD-2510	222	98	31,7	13,7	824	356	526	786	499	92	63,5	47,8

Double-Acting, Precision Production Cylinders

▼ BRD CYLINDER ATTACHMENTS

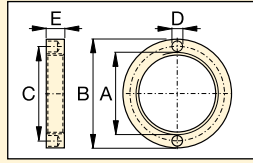

Retainer Nut

For locking foot or flange mountings. Tightens onto cylinder collar threads (Included with foot and flange mounting kits).

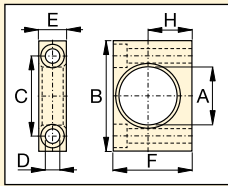

Foot Mounting

Mounts onto cylinder collar.

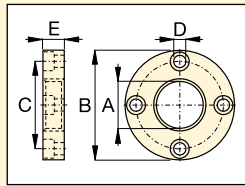

Flange Mounting

Mounts onto cylinder collar.

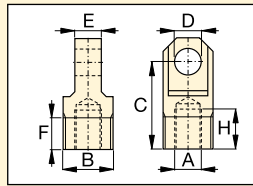

Clevis Eye

Threads onto plunger or into cylinder base.

Model Number	BRD-Cyl. (ton)	Dimensions (mm)						
		A	B	C	D	E	F	H
Foot Mounting with Retainer Nut								
BAD-141	4	42,1	80	58,0	10,5	20,0	57,0	31,8
BAD-171	8	56,1	105	78,0	13,5	25,0	82,5	44,5
BAD-181	15	70,1	127	95,2	20,0	35,0	100,0	52,4
BAD-191	23	85,1	159	117,5	26,5	45,0	125,0	63,5
Flange Mounting with Retainer Nut								
BAD-142	4	42,1	98,4	78,6	11,0	19,0	-	-
BAD-172	8	56,1	121	98,4	11,0	25,4	-	-
BAD-182	15	70,1	143	115,9	16,0	35,0	-	-
BAD-192	23	85,1	165	135,7	17,0	44,5	-	-
Retainer Nut								
BAD-143	4	M42 x 1,5	57	49,5	6,3	9,5	-	-
BAD-173	8	M56 x 2	75	65,5	6,7	12,7	-	-
BAD-183	15	M70 x 2	92	81,0	6,7	19,0	-	-
BAD-193	23	M85 x 2	108	96,5	6,7	25,4	-	-
Clevis Eye (See chart below for mounting dimensions L, L1 and M)								
BAD-150	4	M16 x 1,5	M30 x 1,5	52,4	16,0	15,9	19,1	23,8
BAD-151	8	M22 x 1,5	M42 x 1,5	57,1	20,0	25,4	25,4	23,8
BAD-152	15	M30 x 1,5	M56 x 2	77,8	25,0	31,8	25,4	30,2
BAD-153	23	M42 x 1,5	M70 x 2	77,8	32,0	38,2	25,4	27,0

BRD Series



Capacity:

4 - 23 ton

Stroke:

28 - 260 mm

Maximum Operating Pressure:

700 bar

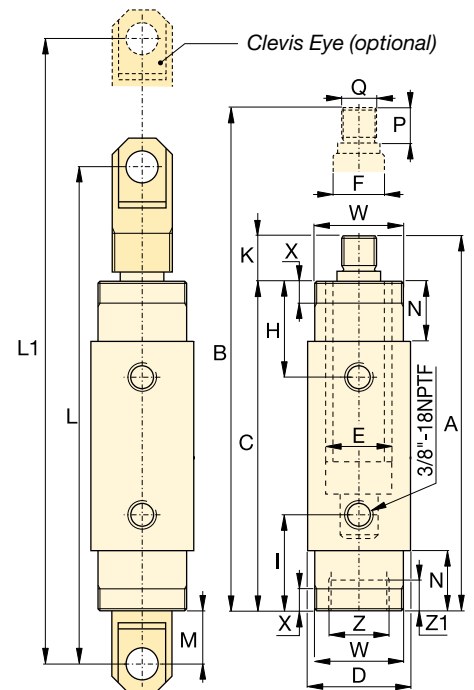

	Top to Retract Port H (mm)	Bottom to Advance Port I (mm)	Plunger Protrusion K (mm)	Clevis Eye Mounting Dimensions			Neck Length N (mm)	Plunger Thread Length P (mm)	Plunger External Thread Q (mm)	Cylinder Mounting Dimensions (mm)				Model Number	
				L (mm)	L1 (mm)	M (mm)				Collar Thread W	Collar Thread Length X	Internal Base Thread Z	Int. Base Thread Length Z1		(kg)
	47	47	24	258	286	41	29	22	M16 x 1,5	M42 x 1,5	11	M30 x 1,5	9	2,0	BRD-41
	47	47	24	308	387	41	29	22	M16 x 1,5	M42 x 1,5	11	M30 x 1,5	9	2,6	BRD-43
	47	47	24	385	540	41	29	22	M16 x 1,5	M42 x 1,5	11	M30 x 1,5	9	3,6	BRD-46
	57	57	25	295	323	38	38	22	M22 x 1,5	M56 x 2	14	M42 x 1,5	14	3,0	BRD-91
	57	57	25	346	425	38	38	22	M22 x 1,5	M56 x 2	14	M42 x 1,5	14	4,2	BRD-93
	57	57	25	422	577	38	38	22	M22 x 1,5	M56 x 2	14	M42 x 1,5	14	5,6	BRD-96
	57	57	25	524	781	38	38	22	M22 x 1,5	M56 x 2	14	M42 x 1,5	14	7,3	BRD-910
	73	73	30	492	651	52	54	28	M30 x 1,5	M70 x 2	22	M56 x 2	24	10,2	BRD-166
	73	73	30	593	853	52	54	28	M30 x 1,5	M70 x 2	22	M56 x 2	24	14,5	BRD-1610
	89	89	27	524	683	53	70	25	M42 x 1,5	M85 x 2	29	M70 x 2	26	16,0	BRD-256
	89	89	27	626	886	53	70	25	M42 x 1,5	M85 x 2	29	M70 x 2	26	20,3	BRD-2510

RR-Series, Double-Acting Cylinders

▼ Shown from left to right: RR-10013, RR-1502, RR-20013, RR-1010, RR-7513



- Collar threads, plunger threads and base mounting holes for easy fixturing (on most models)
- Baked enamel finish for increased corrosion resistance
- Removable hardened saddles protect plunger during lifting and pressing
- Built-in safety valve prevents accidental over-pressurization
- CR-400 couplers and dust caps included on all models
- Plunger wiper reduces contamination, extending cylinder life.

▼ These long stroke RR-cylinders are attached in a sliding and guiding system pulling the arched roof assembly of Athens Olympic Stadium step by step into the final position.



Most Versatile Performers

Rugged enough for the toughest job site uses and precision designed for high-cycle industrial uses.



Saddles

RR-Series cylinders up to 75 ton have plunger mounting holes for installation of CAT-Series tilt saddles.

Page: **33**



Optimum Performance

Enerpac's range of Z-Class electric pumps, fitted with manual or solenoid operated 4-way valves, offer optimum combinations with RR-Series cylinders.

Page: **82**

▼ RR-cylinders provide power and precision in a special hydraulic press.



Double-Acting Long Stroke Cylinders



Pump Selection

A double-acting cylinder must be powered by a pump with a 4-way valve.

Page: **63**

▼ QUICK SELECTION CHART

For complete technical information see next page.

Cylinder Capacity ton (kN)	Stroke (mm)	Model Number	Cylinder Effective Area (cm ²)		Oil Capacity (cm ³)		Coll. Height (mm)
			Push	Pull	Push	Pull	
10 (101)	254	RR-1010	14,5	4,8	368	122	409
	305	RR-1012	14,5	4,8	442	147	457
30 (295)	209	RR-308	42,1	19,1	879	400	395
	368	RR-3014	42,1	19,1	1549	703	549
50 (498)	156	RR-506	71,2	21,5	1111	335	331
	334	RR-5013	71,2	21,5	2378	718	509
	511	RR-5020	71,2	21,5	3638	1099	733
75 (718)	156	RR-756	102,6	31,4	1601	490	347
	333	RR-7513	102,6	31,4	3417	1046	525
95 (933)	168	RR-1006	133,3	62,2	2238	1045	357
	333	RR-10013	133,3	62,2	4439	2071	524
	460	RR-10018	133,3	62,2	6132	2861	687
140 (1386)	57	RR-1502	198,1	95,4	1129	544	196
	156	RR-1506	198,1	95,4	3090	1488	385
	333	RR-15013	198,1	95,4	6597	3177	582
	815	RR-15032	198,1	95,4	16145	7775	1116
200 (1995)	152	RR-2006	285,0	145,3	4332	2209	430
	330	RR-20013	285,0	145,3	9405	4795	608
	457	RR-20018	285,0	145,3	13025	6640	765
	610	RR-20024	285,0	145,3	17385	8863	917
	914	RR-20036	285,0	145,3	26049	13280	1222
325 (3201)	1219	RR-20048	285,0	145,3	34741	17712	1527
	153	RR-3006	457,3	243,2	6997	3721	485
	305	RR-30012	457,3	243,2	13947	7418	638
	457	RR-30018	457,3	243,2	20889	11114	790
	609	RR-30024	457,3	243,2	27850	14811	943
440 (4292)	915	RR-30036	457,3	243,2	41843	22253	1247
	1219	RR-30048	457,3	243,2	55745	29646	1552
	152	RR-4006	613,1	328,1	9319	4987	538
	305	RR-40012	613,1	328,1	18700	10007	690
	457	RR-40018	613,1	328,1	28018	14995	843
520 (5108)	610	RR-40024	613,1	328,1	37400	20014	995
	914	RR-40036	613,1	328,1	56037	29988	1300
	1219	RR-40048	613,1	328,1	74737	39996	1605
	153	RR-5006	729,7	405,4	11164	6203	577
	305	RR-50012	729,7	405,4	22256	12365	730
520 (5108)	457	RR-50018	729,7	405,4	33347	18526	882
	609	RR-50024	729,7	405,4	44440	24689	1035
	915	RR-50036	729,7	405,4	66768	36973	1339
	1219	RR-50048	729,7	405,4	88951	49418	1644

RR Series



Capacity:

10 - 520 ton

Stroke:

57 - 1219 mm

Maximum Operating Pressure:

700 bar



Enerpac HCR-Series

If your application does not require high cycle, Enerpac HCR-Series cylinders may be the right alternative.

Page: **44**



Speed Chart

See the Enerpac Cylinder Speed Chart in our 'Yellow Pages' to determine your approximate cylinder speed.

Page: **269**



Optional Snap-in Saddles

Optional snap-in saddles for RR-Series double-acting cylinders:

Saddle Type	Cylinder Model Number	Saddle Model Number
Flat	RR-1010, 1012	A-102F
	RR-1010, 1012	CAT-10
Tilt	RR-308, 3014	CAT-50
	RR-506, 5013	CAT-100
	RR-5020, 756	
	RR-7513	

Standard Saddles:

Grooved	RR-1010, 1012	A-102G
	RR-308, 3014	A-252G

For additional information on saddles:

Page: **10**

RR-Series, Double-Acting Cylinders

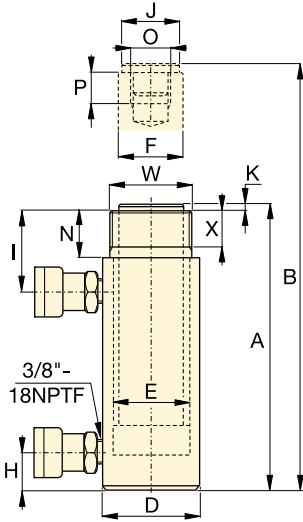

RR-1010 - RR-3014

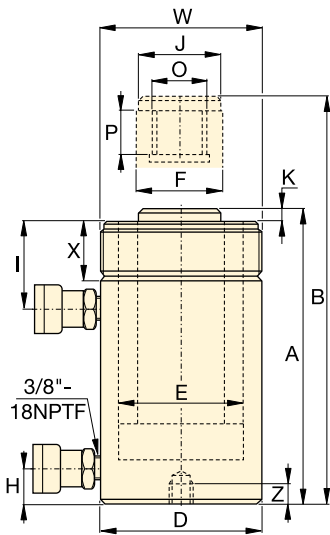

RR-506 - RR-50048

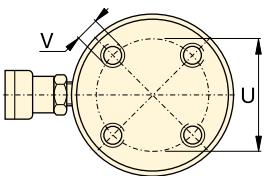

RR-1006 - RR-30048

No mounting holes on:
RR-506, 5013
RR-756, 7513
RR-1502, 15013

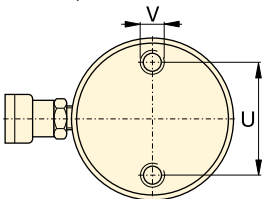

RR-4006 - RR-50048

Base mounting hole location is for reference only, as it is affected by assembly.



Cylinder retract capacity for certain RR cylinders may be less than theoretical values, as a result of reduced relief valve pressure settings:

RR-308/3014: 275 bar
RR-506/5013/5020: 480 bar
RR-756/7513: 495 bar

◀ For full features see previous page.

Cylinder Capacity	Stroke (mm)	Model Number	Max. Cylinder Capacity (kN)		Cylinder Effective Area (cm ²)		Oil Capacity (cm ³)		Coll. Height	Ext. Height	Outside Dia.
			Push	Pull	Push	Pull	Push	Pull	A (mm)	B (mm)	D (mm)
10	254	RR-1010 *	101	33	14,5	4,8	368	122	409	663	73
	305	RR-1012 *	101	33	14,5	4,8	442	147	457	762	73
30	209	RR-308 *	295	53	42,1	19,1	879	400	395	604	101
	368	RR-3014 *	295	53	42,1	19,1	1549	703	549	917	101
50	156	RR-506	498	103	71,2	21,5	1111	335	331	487	127
	334	RR-5013	498	103	71,2	21,5	2378	718	509	843	127
	511	RR-5020	498	103	71,2	21,5	3638	1099	733	1244	127
75	156	RR-756	718	156	102,6	31,4	1601	490	347	503	146
	333	RR-7513	718	156	102,6	31,4	3417	1046	525	858	146
95	168	RR-1006	933	435	133,3	62,2	2238	1045	357	525	177
	333	RR-10013	933	435	133,3	62,2	4439	2071	524	857	177
	460	RR-10018	933	435	133,3	62,2	6132	2861	687	1147	177
140	57	RR-1502	1386	668	198,1	95,4	1129	544	196	253	203
	156	RR-1506	1386	668	198,1	95,4	3090	1488	385	541	203
	333	RR-15013	1386	668	198,1	95,4	6597	3177	582	915	203
	815	RR-15032	1386	668	198,1	95,4	16145	7775	1116	1931	203
200	152	RR-2006	1995	1017	285,0	145,3	4332	2209	430	582	247
	330	RR-20013	1995	1017	285,0	145,3	9405	4795	608	938	247
	457	RR-20018	1995	1017	285,0	145,3	13025	6640	765	1222	247
	610	RR-20024	1995	1017	285,0	145,3	17385	8863	917	1527	247
	914	RR-20036	1995	1017	285,0	145,3	26049	13280	1222	2136	247
	1219	RR-20048	1995	1017	285,0	145,3	34741	17712	1527	2746	247
325	153	RR-3006	3201	1703	457,3	243,2	6997	3721	485	638	311
	305	RR-30012	3201	1703	457,3	243,2	13947	7418	638	943	311
	457	RR-30018	3201	1703	457,3	243,2	20889	11114	790	1247	311
	609	RR-30024	3201	1703	457,3	243,2	27850	14811	943	1552	311
	915	RR-30036	3201	1703	457,3	243,2	41843	22253	1247	2162	311
	1219	RR-30048	3201	1703	457,3	243,2	55745	29646	1552	2771	311
440	152	RR-4006	4292	2297	613,1	328,1	9319	4987	538	690	358
	305	RR-40012	4292	2297	613,1	328,1	18700	10007	690	995	358
	457	RR-40018	4292	2297	613,1	328,1	28018	14995	843	1300	358
	610	RR-40024	4292	2297	613,1	328,1	37400	20014	995	1605	358
	914	RR-40036	4292	2297	613,1	328,1	56037	29988	1300	2214	358
	1219	RR-40048	4292	2297	613,1	328,1	74737	39996	1605	2824	358
520	153	RR-5006	5108	2838	729,7	405,4	11164	6203	577	730	397
	305	RR-50012	5108	2838	729,7	405,4	22256	12365	730	1035	397
	457	RR-50018	5108	2838	729,7	405,4	33347	18526	882	1339	397
	609	RR-50024	5108	2838	729,7	405,4	44440	24689	1035	1644	397
	915	RR-50036	5108	2838	729,7	405,4	66768	36973	1339	2254	397
	1219	RR-50048	5108	2838	729,7	405,4	88951	49418	1644	2863	397

* For RR-1010 and RR-1012: N = 32 mm; for RR-308 and RR-3014: N = 55 mm.

Double-Acting Long Stroke Cylinders

Capacity:
10 - 520 ton

Stroke:
57 - 1219 mm

Maximum Operating Pressure:
700 bar

RR
Series



Cyl. Bore Dia. E (mm)	Plgr. Dia. F (mm)	Base to Adv. Port H (mm)	Top to Ret. Port I (mm)	Saddle Dia. J (mm)	Saddle Protr. fr. Plgr. K (mm)	Plunger Internal Thread O	Plunger Thread Length P (mm)	Base Mounting Holes			Collar Thread W	Collar Thread Length X (mm)	Model Number	
								Bolt Circle U (mm)	Thread V	Thread Depth Z (mm)				
42,9	34,9	36	57	35	6	1" - 8	25	-	-	-	2 1/4" - 14	26	12	RR-1010*
42,9	34,9	36	57	35	6	1" - 8	25	-	-	-	2 1/4" - 14	26	14	RR-1012*
73,2	54,1	39	81	50	10	1 1/2" - 16	25	-	-	-	3 5/16" - 12	49	18	RR-308*
73,2	54,1	39	81	50	10	1 1/2" - 16	25	-	-	-	3 5/16" - 12	49	29	RR-3014*
95,2	79,5	28	76	71	2	1" - 12	25	-	-	-	5" - 12	44	30	RR-506
95,2	79,5	28	76	71	2	1" - 12	25	-	-	-	5" - 12	44	52	RR-5013
95,2	79,5	57	76	71	2	1" - 12	25	76	1/2" - 13	25	5" - 12	44	68	RR-5020
114,3	95,2	30	76	71	6	1" - 12	38	-	-	-	5 3/4" - 12	38	41	RR-756
114,3	95,2	30	81	71	6	1" - 12	38	-	-	-	5 3/4" - 12	38	68	RR-7513
130,3	95,2	38	71	76	3	1 3/4" - 12	35	139	3/4" - 10	25	6 7/8" - 12	50	61	RR-1006
130,3	95,2	38	71	76	3	1 3/4" - 12	35	139	3/4" - 10	25	6 7/8" - 12	50	93	RR-10013
130,3	95,2	41	92	76	3	1 3/4" - 12	35	139	3/4" - 10	25	6 7/8" - 12	50	117	RR-10018
158,8	114,3	22	66	95	19	-	-	-	-	-	-	-	49	RR-1502
158,8	114,3	49	84	114	19	3 3/8" - 16	35	158	3/4" - 16	28	8" - 12	55	93	RR-1506
158,8	114,3	49	84	114	19	3 3/8" - 16	35	158	3/4" - 16	28	8" - 12	55	124	RR-15013
158,8	114,3	76	88	114	19	3 3/8" - 16	35	-	-	-	8" - 12	55	238	RR-15032
190,5	133,4	57	96	133	22	-	-	127	1" - 8	25	-	-	147	RR-2006
190,5	133,4	57	96	133	22	2 1/2" - 12	63	127	1" - 8	25	9 3/4" - 12	54	199	RR-20013
190,5	133,4	85	101	133	22	2 1/2" - 12	63	127	1" - 8	25	9 3/4" - 12	54	204	RR-20018
190,5	133,4	85	101	133	22	2 1/2" - 12	63	127	1" - 8	25	9 3/4" - 12	54	279	RR-20024
190,5	133,4	85	101	133	22	2 1/2" - 12	63	127	1" - 8	25	9 3/4" - 12	54	383	RR-20036
190,5	133,4	85	101	133	22	2 1/2" - 12	63	127	1" - 8	25	9 3/4" - 12	54	483	RR-20048
241,3	165,1	88	114	165	28	2 1/2" - 12	82	158	1 1/4" - 7	44	12 1/4" - 12	58	200	RR-3006
241,3	165,1	88	114	165	28	2 1/2" - 12	82	158	1 1/4" - 7	44	12 1/4" - 12	58	312	RR-30012
241,3	165,1	88	114	165	28	2 1/2" - 12	82	158	1 1/4" - 7	44	12 1/4" - 12	58	385	RR-30018
241,3	165,1	88	114	165	28	2 1/2" - 12	82	158	1 1/4" - 7	44	12 1/4" - 12	58	469	RR-30024
241,3	165,1	88	114	165	28	2 1/2" - 12	82	158	1 1/4" - 7	44	12 1/4" - 12	58	628	RR-30036
241,3	165,1	88	114	165	28	2 1/2" - 12	82	158	1 1/4" - 7	44	12 1/4" - 12	58	780	RR-30048
279,4	190,5	108	133	190	28	3" - 12	95	203	1 1/2" - 6	50	14 1/8" - 8	65	303	RR-4006
279,4	190,5	108	133	190	28	3" - 12	95	203	1 1/2" - 6	50	14 1/8" - 8	65	399	RR-40012
279,4	190,5	108	133	190	28	3" - 12	95	203	1 1/2" - 6	50	14 1/8" - 8	65	453	RR-40018
279,4	190,5	108	133	190	28	3" - 12	95	203	1 1/2" - 6	50	14 1/8" - 8	65	597	RR-40024
279,4	190,5	108	133	190	28	3" - 12	95	203	1 1/2" - 6	50	14 1/8" - 8	65	792	RR-40036
279,4	190,5	108	133	190	28	3" - 12	95	203	1 1/2" - 6	50	14 1/8" - 8	65	980	RR-40048
304,8	203,2	120	152	203	28	3 1/4" - 12	108	203	1 3/4" - 5	57	15 5/8" - 8	79	432	RR-5006
304,8	203,2	120	152	203	28	3 1/4" - 12	108	203	1 3/4" - 5	57	15 5/8" - 8	79	589	RR-50012
304,8	203,2	120	152	203	28	3 1/4" - 12	108	203	1 3/4" - 5	57	15 5/8" - 8	79	680	RR-50018
304,8	203,2	120	152	203	28	3 1/4" - 12	108	203	1 3/4" - 5	57	15 5/8" - 8	79	816	RR-50024
304,8	203,2	120	152	203	28	3 1/4" - 12	108	203	1 3/4" - 5	57	15 5/8" - 8	79	1002	RR-50036
304,8	203,2	120	152	203	28	3 1/4" - 12	108	203	1 3/4" - 5	57	15 5/8" - 8	79	1224	RR-50048

▼ HCL-2006, HCG-2002, HCR-2006



Reaching the Summit Edition:

- Hardened surface resists side-loading and cyclic wear
- Weather protected, inside and out
- Low friction to easily spin the load locking rings ¹⁾
- State of the art bearing materials reduce wear and avoid bore damage even in high side-load conditions

Low wear, high pressure seals

- Improved geometry and material selection increases seal performance even in harsh conditions
- Low friction to improve retraction times

Versatile

- Over 200 models in 4 configurations ¹⁾
- Certified lifting eyes, base mounting holes and collar threads are included for secure handling and cylinder mounting ¹⁾

¹⁾ See specific models technical data for more information.

Highest Level of Durability



The Summit Edition

Innovation is at the heart of the new Summit Edition of cylinders, delivering the high quality construction that you expect from Enerpac. The durability ensures your job gets done safely and reliably.

- Plunger support bearing adds support for eccentric loads ²⁾
- Nitrocarburization surface treatment for improved wear resistance and corrosion protection
- Low wear, high pressure seals provide longer service life.

²⁾ Eccentric load (or "side-load") is inevitable in heavy lifting. Our unique Summit Edition features provide the ultimate protection against side-load. Increased bearing surface maintains stability and nitrocarburization treatment prevents scoring on the inside of the cylinder. Side-load poses a real problem.... our new cylinder features are the solution!

▼ Bridge lifting and launching system. The load is balanced on groups of lock nut cylinders. The hydraulic movements are synchronised using the Enerpac PLC-controlled synchronous lift systems.





High Tonnage Cylinders

The Enerpac High Tonnage Cylinders are particularly suitable for (multipoint) lifting applications.

In combination with our state of the art power packs, you will have a world class hydraulic system to perform the most challenging lifting jobs in a safe and professional manner. See the back page for more information on our pump offering.

HCG, HCR, HCL-Series Cylinders

- 50 - 1000 ton lifting capacity
- 50 - 300 mm lifting stroke

HCG-Series - single-acting

- gravity return
- stop ring to prevent plunger blow-out
- designed to withstand up to 10% side-load of maximum capacity.

HCR-Series - double-acting

- hydraulic advance and retract for controlled movement
- designed to withstand up to 10% side-load of maximum capacity.

HCL-Series - lock nut, single-acting

- gravity return
- lock nut for mechanical load holding
- overflow port to prevent plunger blow out
- designed to withstand 10% side-load up to 90% of maximum stroke.

LPL-Series - lock nut, low height, single-acting (see page 20)

- 60 - 500 ton lifting capacity;
- 45 - 50 mm lifting stroke
- integrated tilt saddle
- gravity return
- lock nut for mechanical load holding
- 5-10% side-load of maximum capacity.

Page: 38

HCG HCR HCL Series



Capacity:

50 - 1000 ton

Stroke:

50 - 300 mm

Maximum Operating Pressure:

700 bar



Assisted Return Pumps

Enerpac HCG, HCL and LPL-Series cylinders are hydraulic advance and gravity return. To improve productivity and plunger retraction

Enerpac offers assisted return on ZU4 and ZE-Series pumps featuring Enerpac Venturi valve technology, specifically to facilitate the faster return of single-acting gravity return cylinders. See enerpac.com for details.

Page: 236



Split-Flow Pumps

SFP-Series pumps with multiple outlets with equal oil flow. For lifting and lowering applications on multiple points these pumps

are a far better alternative than using separately operated pumps.

Page: 236



Synchronous Lifting Systems

Pumps for multiple lift point capabilities. The economical **EVOB-Series** for basic applications and the multi-functional **EVO-Series** lifting system.

Page: 235



QUICK SELECTION

Cylinder Capacity ton	Stroke (mm)	Maximum Cylinder Capacity at 700 bar ton (kN)	HCG-Series		HCR-Series		HCL-Series	
			Model Number Single-Acting <i>Page: 40</i>	Collapsed Height (mm)	Model Number Double-Acting <i>Page: 44</i>	Collapsed Height (mm)	Model Number Single-Acting With Lock Nut <i>Page: 48</i>	Collapsed Height (mm)
50	50	56 (550)	HCG-502	183	HCR-502	183	HCL-502	164
	100		HCG-504	233	HCR-504	233	HCL-504	214
	150		HCG-506	283	HCR-506	283	HCL-506	264
	200		HCG-508	346	HCR-508	346	HCL-508	314
	250		HCG-5010	396	HCR-5010	396	HCL-5010	364
	300		HCG-5012	446	HCR-5012	446	HCL-5012	414
100	50	102 (1002)	HCG-1002	202	HCR-1002	202	HCL-1002	187
	100		HCG-1004	252	HCR-1004	252	HCL-1004	237
	150		HCG-1006	302	HCR-1006	302	HCL-1006	287
	200		HCG-1008	379	HCR-1008	379	HCL-1008	337
	250		HCG-10010	429	HCR-10010	429	HCL-10010	387
	300		HCG-10012	479	HCR-10012	479	HCL-10012	437
150	50	153 (1497)	HCG-1502	220	HCR-1502	220	HCL-1502	209
	100		HCG-1504	270	HCR-1504	270	HCL-1504	259
	150		HCG-1506	320	HCR-1506	320	HCL-1506	309
	200		HCG-1508	397	HCR-1508	397	HCL-1508	359
	250		HCG-15010	447	HCR-15010	447	HCL-15010	409
	300		HCG-15012	497	HCR-15012	497	HCL-15012	459
200	50	202 (1985)	HCG-2002	231	HCR-2002	231	HCL-2002	238
	100		HCG-2004	281	HCR-2004	281	HCL-2004	288
	150		HCG-2006	331	HCR-2006	331	HCL-2006	338
	200		HCG-2008	408	HCR-2008	408	HCL-2008	388
	250		HCG-20010	458	HCR-20010	458	HCL-20010	438
	300		HCG-20012	508	HCR-20012	508	HCL-20012	488
250	50	259 (2541)	HCG-2502	241	HCR-2502	241	HCL-2502	249
	100		HCG-2504	291	HCR-2504	291	HCL-2504	299
	150		HCG-2506	341	HCR-2506	341	HCL-2506	349
	200		HCG-2508	431	HCR-2508	431	HCL-2508	399
	250		HCG-25010	481	HCR-25010	481	HCL-25010	449
	300		HCG-25012	531	HCR-25012	531	HCL-25012	499
300	50	310 (3036)	HCG-3002	296	HCR-3002	296	HCL-3002	278
	100		HCG-3004	346	HCR-3004	346	HCL-3004	328
	150		HCG-3006	396	HCR-3006	396	HCL-3006	378
	200		HCG-3008	446	HCR-3008	446	HCL-3008	428
	250		HCG-30010	496	HCR-30010	496	HCL-30010	478
	300		HCG-30012	546	HCR-30012	546	HCL-30012	528

Enerpac High Tonnage Cylinders

Capacity:
50 - 1000 ton

Stroke:
50 - 300 mm

Maximum Operating Pressure:
700 bar

**HCG
HCR
HCL
Series**



QUICK SELECTION

Cylinder Capacity ton	Stroke (mm)	Maximum Cylinder Capacity at 700 bar ton (kN)	HCG-Series		HCR-Series		HCL-Series	
			Model Number Single-Acting <i>Page: 42</i>	Collapsed Height (mm)	Model Number Double-Acting <i>Page: 46</i>	Collapsed Height (mm)	Model Number Single-Acting With Lock Nut <i>Page: 50</i>	Collapsed Height (mm)
400	50	409 (4008)	HCG-4002	321	HCR-4002	321	HCL-4002	317
	100		HCG-4004	371	HCR-4004	371	HCL-4004	367
	150		HCG-4006	421	HCR-4006	421	HCL-4006	417
	200		HCG-4008	471	HCR-4008	471	HCL-4008	467
	250		HCG-40010	521	HCR-40010	521	HCL-40010	517
	300		HCG-40012	571	HCR-40012	571	HCL-40012	567
500	50	522 (5114)	HCG-5002	344	HCR-5002	344	HCL-5002	357
	100		HCG-5004	394	HCR-5004	394	HCL-5004	407
	150		HCG-5006	444	HCR-5006	444	HCL-5006	457
	200		HCG-5008	494	HCR-5008	494	HCL-5008	507
	250		HCG-50010	544	HCR-50010	544	HCL-50010	557
	300		HCG-50012	594	HCR-50012	594	HCL-50012	607
600	50	611 (5987)	HCG-6002	352	HCR-6002	352	HCL-6002	380
	100		HCG-6004	402	HCR-6004	402	HCL-6004	430
	150		HCG-6006	452	HCR-6006	452	HCL-6006	480
	200		HCG-6008	502	HCR-6008	502	HCL-6008	530
	250		HCG-60010	552	HCR-60010	552	HCL-60010	580
	300		HCG-60012	602	HCR-60012	602	HCL-60012	630
800	50	831 (8149)	HCG-8002	404	HCR-8002	404	HCL-8002	430
	100		HCG-8004	454	HCR-8004	454	HCL-8004	480
	150		HCG-8006	504	HCR-8006	504	HCL-8006	530
	200		HCG-8008	554	HCR-8008	554	HCL-8008	580
	250		HCG-80010	604	HCR-80010	604	HCL-80010	630
	300		HCG-80012	654	HCR-80012	654	HCL-80012	680
1000	50	1085 (10.644)	HCG-10002	442	HCR-10002	442	HCL-10002	484
	100		HCG-10004	492	HCR-10004	492	HCL-10004	534
	150		HCG-10006	542	HCR-10006	542	HCL-10006	584
	200		HCG-10008	592	HCR-10008	592	HCL-10008	634
	250		HCG-100010	642	HCR-100010	642	HCL-100010	684
	300		HCG-100012	692	HCR-100012	692	HCL-100012	734

HCG-Series, High Tonnage Cylinders

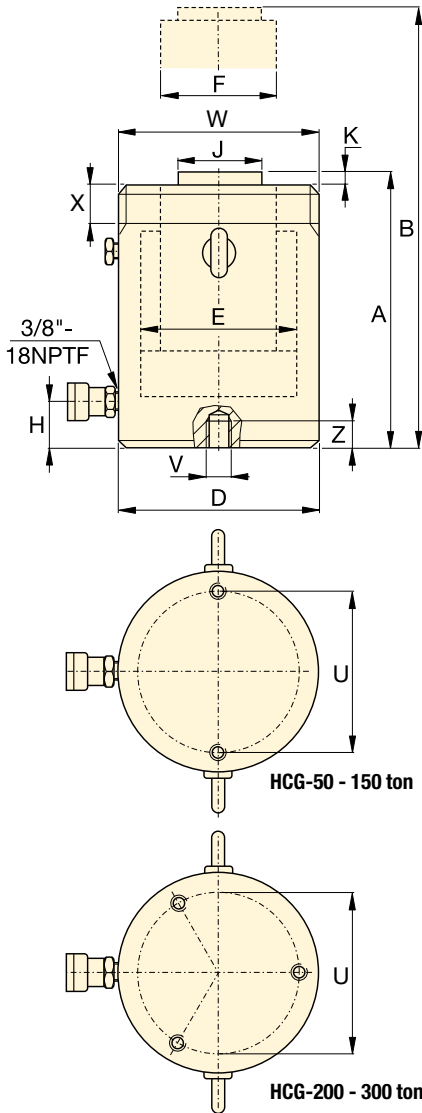

HCG-Series, Single-Acting, Gravity Return Cylinders

- Hardened surface resists side-loading and cyclic wear
- Designed to withstand 10% side-load of maximum capacity ¹⁾
- Stop ring to prevent plunger blow-out
- Weather protected, inside and out
- Upper and lower replaceable bearings enclose the cylinder plunger for support throughout the stroke
- Certified lifting eyes, base mounting holes and collar threads.

SELECTION CHART 50 - 300 TON HCG-MODELS

For 400 - 1000 ton models, see pages 42-43.

For full product features see pages 36-37.

Cylinder Capacity	Stroke	Model Number	Maximum Cylinder Capacity at 700 bar ton (kN)	Cylinder Effective Area	Oil Capacity	Collapsed Height
ton	(mm)			(cm ²)	(cm ³)	A (mm)
50	50	HCG-502	56 (550)	78,5	393	183
	100	HCG-504			785	233
	150	HCG-506 ¹⁾			1178	283
	200	HCG-508			1571	346
	250	HCG-5010			1963	396
	300	HCG-5012 ¹⁾			2356	446
100	50	HCG-1002	102 (1002)	143,1	716	202
	100	HCG-1004			1431	252
	150	HCG-1006			2147	302
	200	HCG-1008			2863	379
	250	HCG-10010			3578	429
	300	HCG-10012			4294	479
150	50	HCG-1502	153 (1497)	213,8	1069	220
	100	HCG-1504			2138	270
	150	HCG-1506			3207	320
	200	HCG-1508			4276	397
	250	HCG-15010			5346	447
	300	HCG-15012			6415	497
200	50	HCG-2002	202 (1985)	283,5	1418	231
	100	HCG-2004			2835	281
	150	HCG-2006			4253	331
	200	HCG-2008			5671	408
	250	HCG-20010			7088	458
	300	HCG-20012			8506	508
250	50	HCG-2502	259 (2541)	363,1	1815	241
	100	HCG-2504			3631	291
	150	HCG-2506			5446	341
	200	HCG-2508			7261	431
	250	HCG-25010			9076	481
	300	HCG-25012			10.892	531
300	50	HCG-3002	310 (3036)	433,7	2169	296
	100	HCG-3004			4337	346
	150	HCG-3006			6506	396
	200	HCG-3008			8675	446
	250	HCG-30010			10.843	496
	300	HCG-30012			13.012	546

Collar Thread (mm)		
Model / Capacity ton	Thread Size	Thread Length
	W	X
HCG-50	M130 x 2	30
HCG-100	M175 x 3	46
HCG-150	M215 x 3	55
HCG-200	M250 x 3	63
HCG-250	M280 x 3	64
HCG-300	M305 x 3	73

The collar thread length is designed for the full rated cylinder capacity.

Base Mounting Holes (mm)					
Model / Capacity ton	Bolt Circle	Thread Size	Minimum Thread Depth	Number of Holes	Angle from Coupler
	U	V	Z		
HCG-50	105	M12 x 1,75	22	2	90°
HCG-100	150	M12 x 1,75	22	2	90°
HCG-150	185	M12 x 1,75	22	2	90°
HCG-200	215	M12 x 1,75	22	3	60°
HCG-250	245	M12 x 1,75	22	3	60°
HCG-300	260	M16 x 2	25	3	60°

¹⁾ HCG-506 and HCG-5012: 7% side-load of maximum capacity.

Single-Acting, High Tonnage Cylinders

Capacity:
50 - 300 ton

Stroke:
50 - 300 mm

Maximum Operating Pressure:
700 bar

HCG
Series

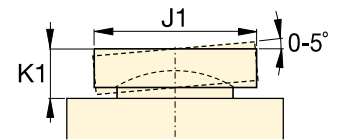

CATG-Serie Tilt Saddle

	Extended Height B (mm)	Outside Diameter D (mm)	Cylinder Bore Diameter E (mm)	Plunger Diameter F (mm)	Base to Advance Port H (mm)	Standard Saddle Diameter J (mm)	Saddle Protrusion from Plunger K (mm)	 (kg)	Model Number	Optional Tilt Saddle		
										Diameter J1 (mm)	Height K1 (mm)	Saddle Model Number
	233	130	100	70	38	50	3	17	HCG-502	50	24	CATG-50
	333							20	HCG-504			
	433							24	HCG-506 ¹⁾			
	546							29	HCG-508			
	646							32	HCG-5010			
	746							36	HCG-5012 ¹⁾			
	252	175	135	95	38	75	3	33	HCG-1002	73	29	CATG-100
	352							40	HCG-1004			
	452							46	HCG-1006			
	579							58	HCG-1008			
	679							65	HCG-10010			
	779							71	HCG-10012			
	270	215	165	120	41	94	3	56	HCG-1502	91	31	CATG-150
	370							66	HCG-1504			
	470							76	HCG-1506			
	597							94	HCG-1508			
	697							104	HCG-15010			
	797							115	HCG-15012			
	281	250	190	140	47	113	3	81	HCG-2002	118	35	CATG-200
	381							95	HCG-2004			
	481							109	HCG-2006			
	608							136	HCG-2008			
	708							150	HCG-20010			
	808							164	HCG-20012			
	291	280	215	170	53	145	4	107	HCG-2502	144	47	CATG-250
	391							125	HCG-2504			
	491							144	HCG-2506			
	631							182	HCG-2508			
	731							201	HCG-25010			
	831							219	HCG-25012			
	346	305	235	200	58	177	4	158	HCG-3002	160	64	CATG-300
	446							182	HCG-3004			
	546							206	HCG-3006			
	646							230	HCG-3008			
	746							254	HCG-30010			
	846							278	HCG-30012			

HCG-Series, Single-Acting, Gravity Return Cylinders

- Hardened surface resists side-loading and cyclic wear
- Designed to withstand 10% side-load of maximum capacity
- Stop ring to prevent plunger blow-out
- Weather protected, inside and out
- Upper and lower replaceable bearings enclose the cylinder plunger for support throughout the stroke
- Certified lifting eyes, base mounting holes and collar threads.

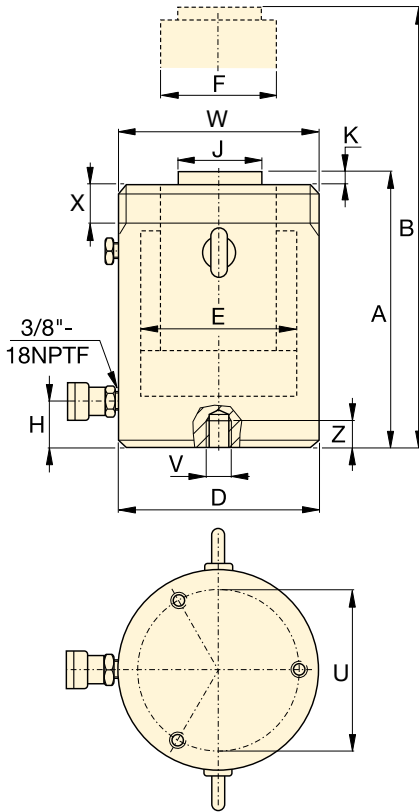

Collar Thread (mm)		
Model / Capacity ton	Thread Size	Thread Length
	W	X
HCG-400	M350 x 3	83
HCG-500	M400 x 4	90
HCG-600	M430 x 4	100
HCG-800	M505 x 5	122
HCG-1000	M570 x 5	137

The collar thread length is designed for the full rated cylinder capacity.

Base Mounting Holes (mm)					
Model / Capacity ton	Bolt Circle	Thread Size	Minimum Thread Depth	Number of Holes	Angle from Coupler
	U	V	Z		
HCG-400	300	M16 x 2	25	3	60°
HCG-500	340	M24 x 3	36	3	60°
HCG-600	370	M24 x 3	36	3	60°
HCG-800	440	M24 x 3	36	3	60°
HCG-1000	500	M24 x 3	36	3	60°

SELECTION CHART 400 - 1000 TON HCG-MODELS

For 50 - 300 ton models, see pages 40-41.

For full product features see pages 36-37.

Cylinder Capacity ton	Stroke (mm)	Model Number	Maximum Cylinder Capacity at 700 bar ton (kN)	Cylinder Effective Area (cm ²)	Oil Capacity (cm ³)	Collapsed Height A (mm)
400	50	HCG-4002	409 (4008)	572,6	2863	321
	100	HCG-4004			5726	371
	150	HCG-4006			8588	421
	200	HCG-4008			11.451	471
	250	HCG-40010			14.314	521
	300	HCG-40012			17.177	571
500	50	HCG-5002	522 (5114)	730,6	3653	344
	100	HCG-5004			7306	394
	150	HCG-5006			10.959	444
	200	HCG-5008			14.612	494
	250	HCG-50010			18.265	544
	300	HCG-50012			21.918	594
600	50	HCG-6002	611 (5987)	855,3	4276	352
	100	HCG-6004			8553	402
	150	HCG-6006			12.829	452
	200	HCG-6008			17.106	502
	250	HCG-60010			21.382	552
	300	HCG-60012			25.659	602
800	50	HCG-8002	831 (8149)	1164,2	5821	404
	100	HCG-8004			11.642	454
	150	HCG-8006			17.462	504
	200	HCG-8008			23.283	554
	250	HCG-80010			29.104	604
	300	HCG-80012			34.925	654
1000	50	HCG-10002	1085 (10.644)	1520,5	7603	442
	100	HCG-10004			15.205	492
	150	HCG-10006			22.808	542
	200	HCG-10008			30.411	592
	250	HCG-100010			38.013	642
	300	HCG-100012			45.616	692

Single-Acting, High Tonnage Cylinders



▲ Offshore wind turbines levelling: Enerpac's synchronous lifting system provided the solution for levelling the supporting cross pieces for 80 wind turbines.

HCG Series



Capacity:
400 - 1000 ton

Stroke:
50 - 300 mm

Maximum Operating Pressure:
700 bar

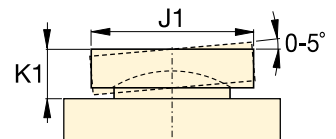

CATG-Series Tilt Saddle

Extended Height B (mm)	Outside Diameter D (mm)	Cylinder Bore Diameter E (mm)	Plunger Diameter F (mm)	Base to Advance Port H (mm)	Standard Saddle Diameter J (mm)	Saddle Protrusion from Plunger K (mm)	Model Number	Optional Tilt Saddle		
								Diameter J1 (mm)	Height K1 (mm)	Saddle Model Number
371	350	270	220	74	196	4	227	193	59	CATG-400
471							257			
571							287			
671							317			
771							347			
871							378			
394	400	305	250	79	228	4	319	228	63	CATG-500
494							359			
594							399			
694							439			
794							479			
894							519			
402	430	330	270	85	247	4	378	241	78	CATG-600
502							424			
602							470			
702							516			
802							562			
902							608			
454	505	385	320	100	297	4	606	287	87	CATG-800
554							671			
654							735			
754							800			
854							864			
954							929			
492	570	440	340	114	323	4	840	311	93	CATG-1000
592							916			
692							992			
792							1068			
892							1145			
992							1221			

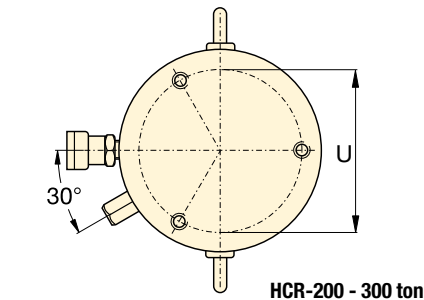
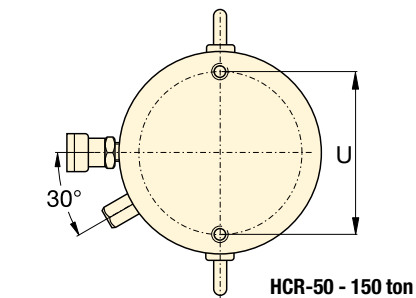
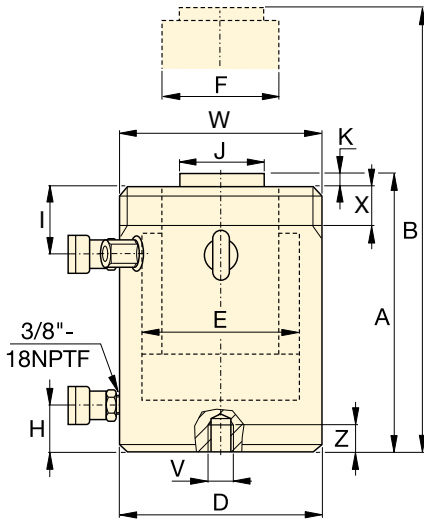

Collar Thread (mm)		
Model / Capacity ton	Thread Size	Thread Length
	W	X
HCR-50	M130 x 2	30
HCR-100	M175 x 3	46
HCR-150	M215 x 3	55
HCR-200	M250 x 3	63
HCR-250	M280 x 3	64
HCR-300	M305 x 3	73

The collar thread length is designed for the full rated cylinder capacity.

Base Mounting Holes (mm)					
Model / Capacity ton	Bolt Circle	Thread Size	Minimum Thread Depth	Number of Holes	Angle from Coupler
	U	V	Z		
HCR-50	105	M12 x 1,75	22	2	90°
HCR-100	150	M12 x 1,75	22	2	90°
HCR-150	185	M12 x 1,75	22	2	90°
HCR-200	215	M12 x 1,75	22	3	60°
HCR-250	245	M12 x 1,75	22	3	60°
HCR-300	260	M16 x 2	25	3	60°

HCR-Series, Double-Acting Cylinders

- Fast advance and retract
- Designed to withstand 10% side-load of maximum capacity¹⁾
- Hardened surface resists side-loading and cyclic wear
- Weather protected, inside and out
- Upper and lower replaceable bearings enclose the cylinder plunger for support throughout the stroke
- Certified lifting eyes, base mounting holes and collar threads.

SELECTION CHART & DETAILS OF 50 - 300 TON HCR-MODELS

For 400 - 1000 ton models, see pages 46-47.

For full product features see pages 36-37

Cylinder Capacity ton	Stroke (mm)	Model Number	Maximum Cylinder Capacity at 700 bar ton (kN)	Cylinder Effective Area (cm ²)	Oil Capacity (cm ³)	Collapsed Height A (mm)
50	50	HCR-502	56 (550)	78,5	393	183
	100	HCR-504			785	233
	150	HCR-506 ¹⁾			1178	283
	200	HCR-508			1571	346
	250	HCR-5010			1963	396
	300	HCR-5012 ¹⁾			2356	446
100	50	HCR-1002	102 (1002)	143,1	716	202
	100	HCR-1004			1431	252
	150	HCR-1006			2147	302
	200	HCR-1008			2863	379
	250	HCR-10010			3578	429
	300	HCR-10012			4294	479
150	50	HCR-1502	153 (1497)	213,8	1069	220
	100	HCR-1504			2138	270
	150	HCR-1506			3207	320
	200	HCR-1508			4276	397
	250	HCR-15010			5346	447
	300	HCR-15012			6415	497
200	50	HCR-2002	202 (1985)	283,5	1418	231
	100	HCR-2004			2835	281
	150	HCR-2006			4253	331
	200	HCR-2008			5671	408
	250	HCR-20010			7088	458
	300	HCR-20012			8506	508
250	50	HCR-2502	259 (2541)	363,1	1815	241
	100	HCR-2504			3631	291
	150	HCR-2506			5446	341
	200	HCR-2508			7261	431
	250	HCR-25010			9076	481
	300	HCR-25012			10.892	531
300	50	HCR-3002	310 (3036)	433,7	2169	296
	100	HCR-3004			4337	346
	150	HCR-3006			6506	396
	200	HCR-3008			8675	446
	250	HCR-30010			10.843	496
	300	HCR-30012			13.012	546

¹⁾ HCR-506 and HCR-5012: 7% side-load of maximum capacity.

Double-Acting, High Tonnage Cylinders

Capacity:
50 - 300 ton

Stroke:
50 - 300 mm

Maximum Operating Pressure:
700 bar

HCR Series

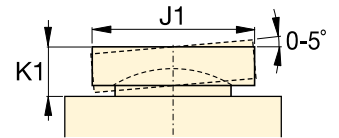

CATG-Series Tilt Saddle

	Extended Height B (mm)	Outside Diameter D (mm)	Cylinder Bore Diameter E (mm)	Plunger Diameter F (mm)	Base to Advance Port H (mm)	Top to Retract Port I (mm)	Standard Saddle Diameter J (mm)	Saddle Protrusion from Plunger K (mm)	 (kg)	Model Number	Optional Tilt Saddle		
											Diameter J1 (mm)	Height K1 (mm)	Saddle Model Number
	233	130	100	70	38	45	50	3	17	HCR-502	50	24	CATG-50
	333								21	HCR-504			
	433								25	HCR-506 ¹⁾			
	546								31	HCR-508			
	646								34	HCR-5010			
	746								38	HCR-5012 ¹⁾			
	252	175	135	95	38	65	75	3	34	HCR-1002	73	29	CATG-100
	352								41	HCR-1004			
	452								48	HCR-1006			
	579								59	HCR-1008			
	679								66	HCR-10010			
	779								73	HCR-10012			
	270	215	165	120	41	70	94	3	56	HCR-1502	91	31	CATG-150
	370								67	HCR-1504			
	470								78	HCR-1506			
	597								95	HCR-1508			
	697								106	HCR-15010			
	797								116	HCR-15012			
	281	250	190	140	47	79	113	3	81	HCR-2002	118	35	CATG-200
	381								96	HCR-2004			
	481								111	HCR-2006			
	608								139	HCR-2008			
	708								153	HCR-20010			
	808								168	HCR-20012			
	291	280	215	170	53	79	145	4	107	HCR-2502	144	47	CATG-250
	391								127	HCR-2504			
	491								146	HCR-2506			
	631								184	HCR-2508			
	731								207	HCR-25010			
	831								227	HCR-25012			
	346	305	235	200	58	101	177	4	159	HCR-3002	160	64	CATG-300
	446								183	HCR-3004			
	546								208	HCR-3006			
	646								232	HCR-3008			
	746								257	HCR-30010			
	846								281	HCR-30012			

HCR-Series, Double-Acting Cylinders

- Fast advance and retract
- Designed to withstand 10% side-load of maximum capacity
- Hardened surface resists side-loading and cyclic wear
- Weather protected, inside and out
- Upper and lower replaceable bearings enclose the cylinder plunger for support throughout the stroke
- Certified lifting eyes, base mounting holes and collar threads.

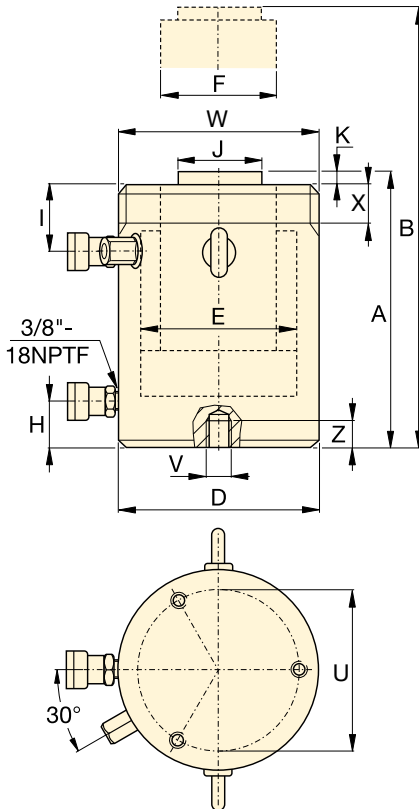

SELECTION CHART & DETAILS OF 400 - 1000 TON HCR-MODELS

For 50 - 300 ton models, see pages 44-45.

For full product features see pages 36-37.

Cylinder Capacity	Stroke	Model Number	Maximum Cylinder Capacity at 700 bar	Cylinder Effective Area	Oil Capacity	Collapsed Height
ton	(mm)		ton (kN)	(cm ²)	(cm ³)	A (mm)
400	50	HCR-4002	409 (4008)	572,6	2863	321
	100	HCR-4004			5726	371
	150	HCR-4006			8588	421
	200	HCR-4008			11.451	471
	250	HCR-40010			14.314	521
	300	HCR-40012			17.177	571
500	50	HCR-5002	522 (5114)	730,6	3653	344
	100	HCR-5004			7306	394
	150	HCR-5006			10.959	444
	200	HCR-5008			14.612	494
	250	HCR-50010			18.265	544
	300	HCR-50012			21.918	594
600	50	HCR-6002	611 (5987)	855,3	4276	352
	100	HCR-6004			8553	402
	150	HCR-6006			12.829	452
	200	HCR-6008			17.106	502
	250	HCR-60010			21.382	552
	300	HCR-60012			25.659	602
800	50	HCR-8002	831 (8149)	1164,2	5821	404
	100	HCR-8004			11.642	454
	150	HCR-8006			17.462	504
	200	HCR-8008			23.283	554
	250	HCR-80010			29.104	604
	300	HCR-80012			34.925	654
1000	50	HCR-10002	1085 (10.644)	1520,5	7603	442
	100	HCR-10004			15.205	492
	150	HCR-10006			22.808	542
	200	HCR-10008			30.411	592
	250	HCR-100010			38.013	642
	300	HCR-100012			45.616	692

Collar Thread (mm)		
Model / Capacity ton	Thread Size	Thread Length
	W	X
HCR-400	M350 x 3	83
HCR-500	M400 x 4	90
HCR-600	M430 x 4	100
HCR-800	M505 x 5	122
HCR-1000	M570 x 5	137

The collar thread length is designed for the full rated cylinder capacity.

Base Mounting Holes (mm)					
Model / Capacity ton	Bolt Circle	Thread Size	Minimum Thread Depth	Number of Holes	Angle from Coupler
	U	V	Z		
HCR-400	300	M16 x 2	25	3	60°
HCR-500	340	M24 x 3	36	3	60°
HCR-600	370	M24 x 3	36	3	60°
HCR-800	440	M24 x 3	36	3	60°
HCR-1000	500	M24 x 3	36	3	60°

Double-Acting, High Tonnage Cylinders



▲ The superlifting and launch of a 43.000-ton floating oil production system in Malaysia for the Gumusut-Kakap offshore field has set high benchmarks for safety through its use of sophisticated EVO-Series synchronous hydraulics to lift, balance, weigh and smoothly launch massive resources structures.

HCR Series



Capacity:
400 - 1000 ton

Stroke:
50 - 300 mm

Maximum Operating Pressure:
700 bar

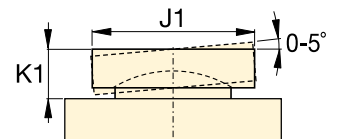

CATG-Series Tilt Saddle

Extended Height B (mm)	Outside Diameter D (mm)	Cylinder Bore Diameter E (mm)	Plunger Diameter F (mm)	Base to Advance Port H (mm)	Top to Retract Port I (mm)	Standard Saddle Diameter J (mm)	Saddle Protrusion from Plunger K (mm)	Model Number	Optional Tilt Saddle		
									Diameter J1 (mm)	Height K1 (mm)	Saddle Model Number
371	350	270	220	74	111	196	4	227	193	59	CATG-400
471								258			
571								289			
671								321			
771								352			
871								383			
394	400	305	250	79	121	228	4	320	228	63	CATG-500
494								361			
594								402			
694								443			
794								484			
894								525			
402	430	330	270	85	121	247	4	379	241	78	CATG-600
502								427			
602								474			
702								521			
802								568			
902								615			
454	505	385	320	100	143	297	4	608	287	87	CATG-800
554								674			
654								740			
754								806			
854								872			
954								938			
492	570	440	340	114	153	323	4	843	311	93	CATG-1000
592								921			
692								1000			
792								1079			
892								1158			
992								1236			

HCL-Series, High Tonnage Lock Nut Cylinders

HCL-Series, Single-Acting, Gravity Return Cylinders

- Lock nut provides positive and safe mechanical load holding
- Low friction to easily spin the load locking rings
- Designed to withstand 10% side-load up to 90% of maximum stroke
- Hardened surface resists side-loading and cyclic wear
- Overflow port as stroke limiter to prevent plunger blow-out
- Weather protected, inside and out
- Replaceable bearings enclose the plunger for support throughout the stroke
- Certified lifting eyes and base mounting holes.

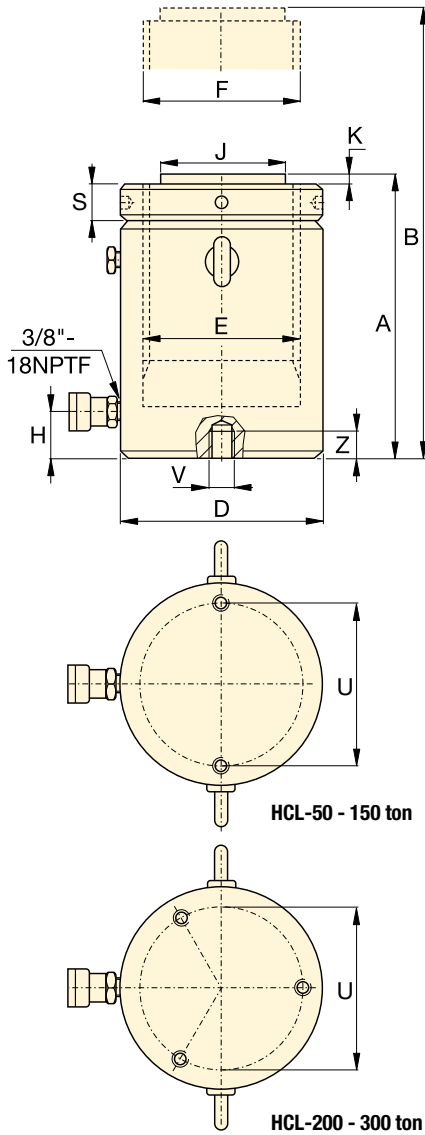

SELECTION CHART 50 - 300 TON HCL-MODELS

For 400 - 1000 ton models, see pages 50-51.

For full product features see pages 36-37.

Cylinder Capacity ton	Stroke (mm)	Model Number	Maximum Cylinder Capacity at 700 bar ton (kN)	Cylinder Effective Area (cm ²)	Oil Capacity (cm ³)	Collapsed Height A (mm)
50	50	HCL-502	56 (550)	78,5	393	164
	100	HCL-504			785	214
	150	HCL-506			1178	264
	200	HCL-508			1571	314
	250	HCL-5010			1963	364
	300	HCL-5012			2356	414
100	50	HCL-1002	102 (1002)	143,1	716	187
	100	HCL-1004			1431	237
	150	HCL-1006			2147	287
	200	HCL-1008			2863	337
	250	HCL-10010			3578	387
	300	HCL-10012			4294	437
150	50	HCL-1502	153 (1497)	213,8	1069	209
	100	HCL-1504			2138	259
	150	HCL-1506			3207	309
	200	HCL-1508			4276	359
	250	HCL-15010			5346	409
	300	HCL-15012			6415	459
200	50	HCL-2002	202 (1985)	283,5	1418	238
	100	HCL-2004			2835	288
	150	HCL-2006			4253	338
	200	HCL-2008			5671	388
	250	HCL-20010			7088	438
	300	HCL-20012			8506	488
250	50	HCL-2502	259 (2541)	363,1	1815	249
	100	HCL-2504			3631	299
	150	HCL-2506			5446	349
	200	HCL-2508			7261	399
	250	HCL-25010			9076	449
	300	HCL-25012			10.892	499
300	50	HCL-3002	310 (3036)	433,7	2169	278
	100	HCL-3004			4337	328
	150	HCL-3006			6506	378
	200	HCL-3008			8675	428
	250	HCL-30010			10.843	478
	300	HCL-30012			13.012	528

Base Mounting Holes (mm)					
Model / Capacity ton	Bolt Circle U	Thread Size V	Minimum Thread Depth Z	Number of Holes	Angle from Coupler
HCL-50	105	M8 x 1,25	10	2	90°
HCL-100	150	M12 x 1,75	17	2	90°
HCL-150	185	M12 x 1,75	22	2	90°
HCL-200	215	M12 x 1,75	22	3	60°
HCL-250	245	M12 x 1,75	22	3	60°
HCL-300	260	M16 x 2	25	3	60°

Single-Acting, Lock Nut Cylinders

Capacity:
50 - 300 ton

Stroke:
50 - 300 mm

Maximum Operating Pressure:
700 bar

HCL Series

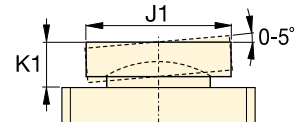

CAT-Series Tilt Saddle

	Extended Height B (mm)	Outside Diameter D (mm)	Cylinder Bore Diameter E (mm)	Plunger Diameter (threaded) F (mm)	Base to Advance Port H (mm)	Standard Saddle Diameter J (mm)	Saddle Protrusion from Plunger K (mm)	Lock Nut Height S (mm)	 (kg)	Model Number	Optional Tilt Saddle		
											Diameter J1 (mm)	Height K1 (mm)	Saddle Model Number
	214	130	100	Tr 100 x 4	24	71	2	25	17	HCL-502	71	24	CAT-100
	314								22	HCL-504			
	414								27	HCL-506			
	514								32	HCL-508			
	614								38	HCL-5010			
	714								43	HCL-5012			
	237	175	135	Tr 135 x 6	33	71	2	33	35	HCL-1002	71	24	CAT-100
	337								44	HCL-1004			
	437								54	HCL-1006			
	537								63	HCL-1008			
	637								73	HCL-10010			
	737								82	HCL-10012			
	259	215	165	Tr 165 x 6	41	130	2	40	59	HCL-1502	130	19	CAT-200
	359								73	HCL-1504			
	459								87	HCL-1506			
	559								102	HCL-1508			
	659								116	HCL-15010			
	759								130	HCL-15012			
	288	250	190	Tr 190 x 6	47	130	2	45	85	HCL-2002	130	19	CAT-200
	388								105	HCL-2004			
	488								124	HCL-2006			
	588								143	HCL-2008			
	688								163	HCL-20010			
	788								182	HCL-20012			
	299	280	215	Tr 215 x 6	53	150	2	52	119	HCL-2502	150	19	CAT-250
	399								143	HCL-2504			
	499								167	HCL-2506			
	599								192	HCL-2508			
	699								216	HCL-25010			
	799								240	HCL-25012			
	328	305	235	Tr 235 x 6	58	140	2	56	158	HCL-3002	195	73	CAT-300
	428								186	HCL-3004			
	528								215	HCL-3006			
	628								244	HCL-3008			
	728								272	HCL-30010			
	828								301	HCL-30012			

HCL-Series, High Tonnage Lock Nut Cylinders

HCL-Series, Single-Acting, Gravity Return Cylinders

- Lock nut provides positive and safe mechanical load holding
- Low friction to easily spin the load locking rings
- Designed to withstand 10% side-load up to 90% of maximum stroke
- Hardened surface resists side-loading and cyclic wear
- Overflow port as stroke limiter to prevent plunger blow-out
- Weather protected, inside and out
- Replaceable bearings enclose the plunger for support throughout the stroke
- Certified lifting eyes and base mounting holes.

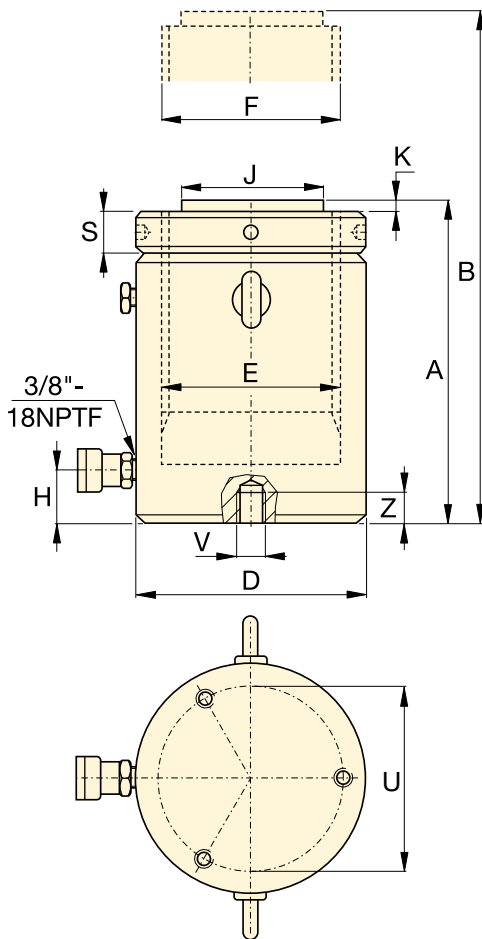

SELECTION CHART 400 - 1000 TON HCL-MODELS

For 50 - 300 ton models, see pages 48-49.

For full product features see pages 36-37.

Cylinder Capacity	Stroke	Model Number	Maximum Cylinder Capacity at 700 bar ton (kN)	Cylinder Effective Area (cm ²)	Oil Capacity (cm ³)	Collapsed Height A (mm)
ton	(mm)					
400	50	HCL-4002	409 (4008)	572,6	2863	317
	100	HCL-4004			5726	367
	150	HCL-4006			8588	417
	200	HCL-4008			11.451	467
	250	HCL-40010			14.314	517
	300	HCL-40012			17.177	567
500	50	HCL-5002	522 (5114)	730,6	3653	357
	100	HCL-5004			7306	407
	150	HCL-5006			10.959	457
	200	HCL-5008			14.612	507
	250	HCL-50010			18.265	557
	300	HCL-50012			21.918	607
600	50	HCL-6002	611 (5987)	855,3	4276	380
	100	HCL-6004			8553	430
	150	HCL-6006			12.829	480
	200	HCL-6008			17.106	530
	250	HCL-60010			21.382	580
	300	HCL-60012			25.659	630
800	50	HCL-8002	831 (8149)	1164,2	5821	430
	100	HCL-8004			11.642	480
	150	HCL-8006			17.462	530
	200	HCL-8008			23.283	580
	250	HCL-80010			29.104	630
	300	HCL-80012			34.925	680
1000	50	HCL-10002	1085 (10.644)	1520,5	7603	484
	100	HCL-10004			15.205	534
	150	HCL-10006			22.808	584
	200	HCL-10008			30.411	634
	250	HCL-100010			38.013	684
	300	HCL-100012			45.616	734

Base Mounting Holes (mm)					
Model / Capacity ton	Bolt Circle U	Thread Size V	Minimum Thread Depth Z	Number of Holes	Angle from Coupler
HCL-400	300	M16 x 2	25	3	60°
HCL-500	340	M24 x 3	36	3	60°
HCL-600	370	M24 x 3	36	3	60°
HCL-800	440	M24 x 3	36	3	60°
HCL-1000	500	M24 x 3	36	3	60°

Single-Acting, Lock Nut Cylinders



▲ Heavy lifting and foundation levelling. The lock nut provides mechanical load holding over a long period of time.

HCL Series



Capacity:
400 - 1000 ton

Stroke:
50 - 300 mm

Maximum Operating Pressure:
700 bar

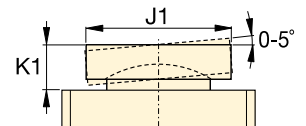

CAT-Series Tilt Saddle

Extended Height B (mm)	Outside Diameter D (mm)	Cylinder Bore Diameter E (mm)	Plunger Diameter (threaded) F (mm)	Base to Advance Port H (mm)	Standard Saddle Diameter J (mm)	Saddle Protrusion from Plunger K (mm)	Lock Nut Height S (mm)	 (kg)	Model Number	Optional Tilt Saddle		
										Diameter J1 (mm)	Height K1 (mm)	Model Number
367	350	270	Tr 270 x 6	67	159	5	65	236	HCL-4002	225	85	CAT-400
467								274	HCL-4004			
567								311	HCL-4006			
667								349	HCL-4008			
767								387	HCL-40010			
867								425	HCL-40012			
407	400	305	Tr 305 x 6	75	179	5	72	341	HCL-5002	250	91	CAT-500
507								390	HCL-5004			
607								439	HCL-5006			
707								489	HCL-5008			
807								538	HCL-50010			
907								587	HCL-50012			
430	430	330	Tr 330 x 6	81	194	5	80	427	HCL-6002	275	99	CAT-600
530								484	HCL-6004			
630								541	HCL-6006			
730								598	HCL-6008			
830								655	HCL-60010			
930								712	HCL-60012			
480	505	385	Tr 385 x 6	95	224	5	90	668	HCL-8002	320	124	CAT-800
580								746	HCL-8004			
680								825	HCL-8006			
780								904	HCL-8008			
880								982	HCL-80010			
980								1061	HCL-80012			
534	570	440	Tr 440 x 6	110	249	5	105	959	HCL-10002	360	136	CAT-1000
634								1059	HCL-10004			
734								1160	HCL-10006			
834								1260	HCL-10008			
934								1360	HCL-100010			
1034								1460	HCL-100012			

▼ SCR-1010H cylinder-pump set



The Quickest and Easiest Way to Start Working Right Away





Speed Chart

See the Enerpac Cylinder Speed Chart in our 'Yellow Pages' section.

Page: **269**

- Optimum match of individual components
- All sets are ready-for-use
- Sets include 1,8 m safety hose and gauge with gauge adaptor
- All pumps are two-speed.

<div style="display: flex; align-items: center;"> 1 <div> <p>Cylinder Selection (See Cylinder Section of this catalog for full product descriptions)</p> </div> </div>		Set Capacity ton (kN)	Cylinder Model Number	Stroke (mm)	Collapsed Height (mm)
 <p>RC-Series, Single-Acting, General Purpose Cylinders For maximum versatility.</p>	5 (45)	RC-55	127	215	
		RC-102	54	121	
	10 (101)	RC-106	156	247	
		RC-1010	257	349	
		RC-154	101	200	
	15 (142)	RC-156	152	271	
		25 (232)	RC-252	50	165
	RC-254		102	215	
	RC-256		158	273	
	RC-2514		362	476	
50 (498)	RC-506	159	282		
 <p>RCS-Series, Single-Acting, Low Height Cylinders Ideal where space is restricted.</p>	10 (101)	RCS-101	38	88	
	20 (201)	RCS-201	45	98	
	30 (295)	RCS-302	62	117	
	45 (435)	RCS-502	60	122	
	90 (887)	RCS-1002	57	141	
 <p>RCH-Series, Single-Acting, Hollow Cylinders For pushing and pulling applications.</p>	13 (125)	RCH-121	42	120	
	20 (215)	RCH-202	49	162	
	30 (326)	RCH-302	64	178	
	60 (576)	RCH-603	76	247	
	95 (933)	RCH-1003	76	254	

Page: **6**

Page: **22**

Page: **26**

Single-Acting Cylinder-Pump Sets

SET SELECTION:

- 1 Select the cylinder
- 2 Select the pump
- 3 Find the set model number in the gray matrix

SELECTION EXAMPLE

Selected cylinder:

- RC-106, Single-Acting cylinder with 156 mm stroke

Selected pump:

- P-392, Lightweight hand pump

Set model number:

- SCR-106H

Included:

- HC-7206 hose
- GF-10B gauge
- GA-2 adaptor

SC Series



Capacity:

5 - 95 ton

Stroke:

38 - 362 mm

Maximum Operating Pressure:

700 bar



Power Box

Tool box with hand pump, gauge adaptor assembly, hose and LW-, RC-, RCS, RSM- or WR-Series cylinder.

Page: 55

2

Pump selection (See the Pump Section in this catalog for full product descriptions.)

Accessories included

3

Hand Pump P-142	Hand Pump P-392	Hand Pump P-80	Foot Pump P-392FP	XA-Series Air Pump XA-11	XC-Series Cordless Pump XC-1201ME ²⁾	Hose Model Number	Gauge Model Number	Gauge Adaptor Model Nr.
SCR-55H	-	-	-	-	-	HC-7206	GP-10S	GA-4
-	SCR-102H	-	SCR-102FP	SCR-102XA	SCR-102XCE	HC-7206	GF-10B	GA-2
-	SCR-106H	-	SCR-106FP	SCR-106XA	SCR-106XCE	HC-7206	GF-10B	GA-2
-	SCR-1010H	-	SCR-1010FP	SCR-1010XA	SCR-1010XCE	HC-7206	GF-10B	GA-2
-	SCR-154H	-	SCR-154FP	SCR-154XA	SCR-154XCE	HC-7206	GP-10S	GA-2
-	SCR-156H	-	SCR-156FP	SCR-156XA	SCR-156XCE	HC-7206	GP-10S	GA-2
-	SCR-252H	-	SCR-252FP	SCR-252XA	SCR-252XCE	HC-7206	GF-20B	GA-2
-	SCR-254H	-	SCR-254FP	SCR-254XA	SCR-254XCE	HC-7206	GF-20B	GA-2
-	SCR-256H	-	-	SCR-256XA	SCR-256XCE	HC-7206	GF-20B	GA-2
-	-	SCR-2514H	-	SCR-2514XA ¹⁾	-	HC-7206	GF-20B	GA-2
-	-	SCR-506H	-	SCR-506XA ¹⁾	-	HC-7206	GF-50B	GA-2
-	SCL-101H	-	SCL-101FP	SCL-101XA	-	HC-7206	GF-10B	GA-2
-	SCL-201H	-	SCL-201FP	SCL-201XA	-	HC-7206	GF-230B	GA-2
-	SCL-302H	-	SCL-302FP	SCL-302XA	SCL-302XCE	HC-7206	GF-230B	GA-2
-	SCL-502H	-	SCL-502FP	SCL-502XA	SCL-502XCE	HC-7206	GF-510B	GA-2
-	-	SCL-1002H	-	-	SCL-1002XCE	HC-7206	GF-510B	GA-2
SCH-121H	-	-	-	-	-	HB-7206	GF-120B	GA-4
-	SCH-202H	-	SCH-202FP	SCH-202XA	SCH-202XCE	HC-7206	GF-813B	GA-3
-	SCH-302H	-	SCH-302FP	SCH-302XA	SCH-302XCE	HC-7206	GF-813B	GA-3
-	-	SCH-603H	-	SCH-603XA ¹⁾	SCH-603XCE	HC-7206	GF-813B	GA-3
-	-	SCH-1003H	-	-	-	HC-7206	GP-10S	GA-2

¹⁾ With XA-12 air pump.

²⁾ Cordless Pump includes 230V Charger. For 115V charger replace the "E" by the "B" in the model number.

▼ From left to right: P-142ALSS, P-392ALSS, V-152NV, V-66NV, RC-256NV, RC-106NV, RC-53NV



- Corrosion resistant, nickel-plated valves and cylinders
- Stainless steel pump inserts will not corrode
- Viton® Seals provide heat and chemical resistance
- Anodized aluminum pump reservoirs and plastic encapsulated pump bodies resist wet environments
- Two-speed operation reduces pump handle strokes 78% compared to single-speed pumps
- Pump handles lock for easy carrying.

RC, P, V Series

Cylinder Capacity:
5 - 25 ton

Stroke:
51 - 156 mm

Maximum Operating Pressure:
700 bar



Applications



For use in wet environments such as food processing, pulp and paper, mining, construction and applications in high temperature or in welding areas.







Multifluid Hand Pumps

MP-Series corrosion resistant hand pumps for low pressure filling and high pressure testing applications, suitable for a wide range of fluids.

Page: **70**

	Cylinder Capacity	Stroke	Model Number *	Oil Capacity	Pressure Rating	Collapsed Height	Extended Height	Outside Diameter	
	ton (kN)	(mm)		(cm ³)	(bar)	(mm)	(mm)	(mm)	(kg)
	5 (45)	76	RC-53NV	50	700	165	241	38	1,5
	10 (101)	51	RC-102NV	78	700	121	175	57	2,3
	10 (101)	156	RC-106NV	225	700	247	403	57	4,4
	25 (232)	156	RC-256NV	528	700	273	431	85	10,0

	Pump Type	Oil Capacity	Model Number *	Pressure Rating	Oil Displacement per Stroke	Port Dimension	Piston Stroke	
		(cm ³)		(bar)	(cm ³)	(NPTF)	(mm)	(kg)
	Two Speed	327	P-142ALSS	14 / 700	3,62 / 0,90	1/4"-18	12,7	2,0
		901	P-392ALSS	14 / 700	11,26 / 2,47	3/8"-18	25,4	4,1

	Valve Type	Model Number *	Function	Pressure Rating (bar)	
	Manual Check Valve	V-66NV *	Load holding with cylinders	700	1,8
	Pressure Relief Valve	V-152NV *	Limits system pressure, ± 3% repeatability	55-700	1,6

* For cylinder details see pages 7-9; for pump details see pages 64-65; for valve details see pages 130-131.

Power Box – Portable Tool Sets

▼ SCR154PGH



- Easy to carry sturdy tool box
- Complete and ready-to-use hydraulic sets
- Includes a single-acting cylinder, P-392 two-speed lightweight hand pump, gauge adaptor assembly, 1,8 metre hose and couplers.

**SC,
SL,
SR,
SW
Series**



Capacity:

1 - 45 ton

Stroke:

11 - 156 mm

Maximum Operating Pressure:







700 bar



Gauge Adaptor Assembly

Power Box Sets include 45 degree angled gauge adaptor assembly for improved safe working conditions.

Page: 128

	Cylinder Model	Cylinder Stroke (mm)	Cylinder Capacity ton (kN)	 (kg)	Power Box Model Number
	Lifting Wedge				
	LW-16	21	16 (157)	9,0	SLW16PGH
	Wedge Spread Cylinder				
	WR-5	94 ¹⁾	1,0 (8,9)	12,0	SWR5PGH
	General Purpose Cylinders				
	RC-102	54	10 (101)	12,3	SCR102PGH
	RC-106	156	10 (101)	14,4	SCR106PGH
	RC-154	101	15 (142)	15,0	SCR154PGH
	Low Height Cylinders				
	RCS-101	38	10 (101)	14,1	SCL101PGH
	RCS-201	45	20 (201)	15,0	SCL201PGH
	Flat-Jac® Cylinders				
	RSM-100	11	10 (101)	11,4	SRS100PGH
	RSM-200	11	20 (201)	13,1	SRS200PGH
	RSM-300	13	30 (295)	14,5	SRS300PGH
	RSM-500	16	45 (435)	16,8	SRS500PGH

¹⁾ Maximum spread of WR-5.

▼ The Power Box – the portable tool set – applicable everywhere



▼ Shown from left to right: JHA-356, JHA-156



JH, JHA Series

Capacity:
7 - 150 ton

Stroke:
76 - 155 mm

Maximum Operating Pressure:
700 bar

- All-directional operation on 7, 15 and 35 ton JHA-series
- Internal relief valve to prevent overloading
- Machined flat front and bottom surfaces permit flush alignment in tight corners
- Chrome plated plungers
- Pumping handle included
- Automatic by-pass port to prevent over-extension (JH-series).



Lifting Wedge and Machine Lifts

Ideal to lift the load the first few centimeters. The LW-16 Lifting Wedge requires a very small access gap of only 10 mm.

Page: **166**



Load Skates

For moving heavy loads easily and safely.

Page: **168**

Style	Jack Capacity ton (kN)	Stroke (mm)	Model Number	Jack Effective Area (cm ²)	Collapsed Height (mm)	Extended Height (mm)	Bottom Plate Dimensions W x L (mm)	Plunger Diameter (mm)	Pump Speed	 (kg)
Aluminium Jacks	7 (62)	76	JHA-73	9,6	133	209	73 x 158	30,2	Single	5,0
	15 (133)	153	JHA-156	20,3	247	401	92 x 238	41,4	Single	13,2
	35 (311)	155	JHA-356	45,6	257	412	117 x 254	54,1	Single	18,1
	75 (667)	153	JHA-756	102,6	285	439	174 x 325	114,3	Single	42,6
	150 (1335)	155	JHA-1506	197,9	327	482	241 x 407	158,8	2-Speed	95,3
Steel Jacks	30 (267)	155	JH-306	38,3	254	409	95 x 242	69,9	Single	26,8
	50 (445)	154	JH-506	62,1	260	414	127 x 258	88,9	2-Speed	40,8
	100 (890)	153	JH-1006	133,1	287	440	181 x 328	130,1	2-Speed	74,4

Industrial Steel Bottle Jacks

▼ Shown: GBJ-010, GBJ-030, GBJ-003



- Lower handle effort reduces operator fatigue
- Fully serviceable
- High-strength beam and pump linkage for long life
- Pumping handle included on all models
- Safety relief valve to prevent overload
- Automatic by-pass port to prevent over-extension
- Wiper seal for extended life
- Thick base material with large area for increased strength and stability during lifting.

GBJ Series



Capacity:

2 - 100 ton

Stroke:

62 - 460 mm



Screw Extension Feature

Heat treated, adjustable extension screw with cleated saddle on selected GBJ models helps adjusting and prevents slipping.

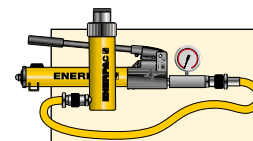

Cylinder-Pump Sets

As an alternative to bottle jacks where the operator is required to stand remote from the jacking point, see our range of cylinder-pump sets.

Page: **52**

Capacity ton (kN)	Stroke (mm)	Model Number	Screw Extension (mm)	Min. Height (mm)	Max. Height (mm)	Plunger diameter (mm)	Saddle Diameter (mm)	Bottom Dimensions W x L (mm)	 (kg)
2 (19,6)	460	GBJ002L	-	570	1030	29,0	-	127 x 127	6,0
2 (19,6)	100	GBJ002	50	160	310	21,0	21	95 x 111	3,6
3 (29,4)	105	GBJ003	65	168	338	24,0	24	95 x 116	3,9
5 (49,0)	150	GBJ005	75	212	437	29,0	29	95 x 123	5,0
8 (78,4)	150	GBJ008	75	219	444	33,0	37	95 x 138	5,9
10 (98,0)	150	GBJ010	75	219	444	37,0	37	95 x 142	6,5
10 (98,0)	62	GBJ010S	30	131	223	37,0	37	95 x 142	5,5
15 (147,0)	150	GBJ015	75	228	453	44,5	44	112 x 163	9,0
20 (196,0)	150	GBJ020	75	234	459	51,0	58	127 x 171	12,1
20 (196,0)	105	GBJ020S	55	190	350	51,0	58	127 x 171	10,0
30 (294,0)	150	GBJ030	75	242	467	57,5	65	142 x 196	15,5
50 (490,0)	150	GBJ050	-	252	402	80,0	80	180 x 230	28,5
100 (980,0)	150	GBJ100	-	300	450	110,0	94	296 x 333	87,0

All GBJ Jacks meet or exceed: ANSI, PALD, CE.

▼ Enerpac heavy-duty bottle jacks make lifting loads easier.



▼ Shown: PRASA10027L and accessory Locking U-Rings



Safe, Efficient, Mobile Load Lifting



Pendant cord

Supplied with 3,5 m pendant cord for air driven units with pneumatic valves and 6 m pendant cord for electric driven units keeps operator away from the load.

- 54, 90, 136 and 181 ton capacities with pneumatic or electric pumps for the toughest jobs
- 102 mm ground clearance for transport over rail and rough terrain
- Double-acting cylinder
- Three position handle provides easy tilt back and transport
- Complies with ASME/ANSI B30:1 2015 and CE specifications
- Easy to change external filter minimizes down time
- Rugged, fully enclosed 610 mm wide frame with no exposed fittings or hoses
- SUP-R-STACK™ Extension System allows lifting at all heights without blocking.



POW'R LOCK – Self-Locking Mobile Lift System

A self-locking jack that performs automatic locking during lifting, lowering and holding.

See the Enerpac PL-Series

Page: **60**



◀ Enerpac POW'R-RISER® used in mining operations to lift heavy equipment.

Capacity ton (kN)	Stroke (mm)	Model Number with Electric Pump (230V - 1 ph - 50Hz)	 (kg)
54 (533)	356	PREME06014L	177
	686	PREME06027L	272
90 (889)	406	PREME10016L	231
	686	PREME10027L	272
	406	-	-
	686	-	-
136 (1333)	394	-	-
	673	-	-
	394	PREME15016L	258
	673	PREME15027L	321
181 (1778)	388	-	-
	617	-	-

POW'R-RISER® Lifting Jack



SUP-R-STACK Extensions

Increase useful height from 127 to 457 mm.

Model No.	Size (mm)	Model No.	Size (mm)
PRE5	127	PRE11	279
PRE7	178	PRE14	356
PRE9	229	PRE18	457
PRES6024	Extension set includes PRE5, PRE7, PRE11 and PRE18.		



Spacers

Fine tune your extension stack height.

Model No.	Size (mm)	Model No.	Size (mm)
PRS1	25	PRS3	76
PRS2	51	-	-
PRS4	Set includes (2x) PRS1, (1x) PRS2 and (1x) PRS3.		

PR Series



Rated Lifting Capacity:

54 - 181 ton

Stroke:

356 - 686 mm

Maximum Operating Pressure:

700 bar

Cap. (kN)	Swivel Load Saddle	Locking U-Rings					Set Model Number	Locking U-Ring Sets Include:								
		25 mm	76 mm	114 mm	140 mm	254 mm		Quantity & model numbers								
533	PRTS60	PRU11	PRU13	PRU14	-	PRU110	¹⁾ PRUS126	PRU11	PRU13	PRU14	-	²⁾ PRUS137	PRU11	PRU13	PRU14	PRU110
889	PRTS60	PRU11	PRU13	PRU14	-	PRU110	¹⁾ PRUS126	PRU11	PRU13	PRU14	-	²⁾ PRUS137	PRU11	PRU13	PRU14	PRU110
1333	PRTS150	PRU151	PRU153	-	PRU155	PRU1510	³⁾ PRUS1526	PRU151	PRU153	PRU155	-	²⁾ PRUS1537	PRU151	PRU1510	PRU155	-
1778	PRTS200	PRU201	PRU203	-	PRU205	PRU2010	³⁾ PRUS2026	PRU201	PRU203	PRU205	-	²⁾ PRUS2037	PRU201	PRU2010	PRU205	-

¹⁾ For 356 mm and 406 mm stroke models

²⁾ For 686 mm stroke models

³⁾ For 394 mm stroke models.

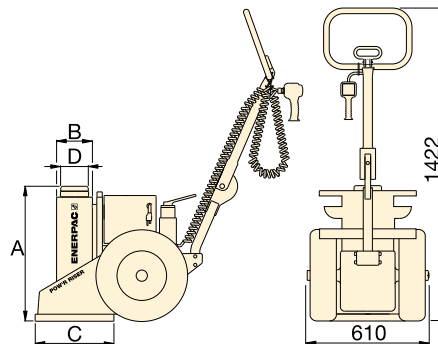

WARNING!

Extensions: Any two extensions may be stacked for loads up to 54 ton. For loads over 54 ton or strokes over 356 mm only one extension and one spacer can be used.

Spacers: Never exceed 76 mm in total spacer height.

Model Number with Air Pump	(kg)	A (mm)	B (mm)	C (mm)	D (mm)	Max. Additional Stack Height Using Optional Extension (mm)	Valve Type
PRAMA06014L	177	610	162	356	102	813*	Manual
PRAMA06027L	272	940	162	356	102	279	
PRAMA10016L	231	660	178	457	102	533**	
PRAMA10027L	272	940	178	457	102	279	
PRASA10016L	231	660	178	457	102	533**	Pneumatic
PRASA10027L	272	940	178	457	102	279	
PRASA15016L	258	660	203	457	127	533**	
PRASA15027L	321	940	203	457	127	279	Manual
-	-	660	203	457	127	533**	
-	-	940	203	457	127	279	Pneumatic
PRASA20016L	290	660	241	508	165	533**	
PRASA20027L	374	940	241	508	165	279	

* Based on one 457 mm and one 279 mm extension and one 76 mm spacer.

** Based on one 457 mm extension and one 76 mm spacer.

For power source, the following characters should be inserted in the 5th space of the model number.

Ordering Example:

Model No. PREME06014L is a 356 mm stroke, 54 ton model, with a manual valve and a 230 VAC, 1-ph, 50 Hz electric motor.

A Air Pump, 1416 l/min air consumption at 5,5 bar

B 115 VAC, 1-ph., 50-60 Hz, 20 A

E 208-240 VAC, 1-ph., 50-60 Hz, Euro Plug, 10 A

I 208-240 VAC, 1-ph., 50-60 Hz, USA Plug, 10 A

G ¹⁾ 208-240 VAC, 3-ph., 50-60 Hz

W ¹⁾ 380-415 VAC, 3-ph., 50-60 Hz

J ¹⁾ 440-480 VAC, 3-ph., 50-60 Hz

R ¹⁾ 575 VAC, 3-ph., 50-60 Hz.

¹⁾ Not available for 54 ton capacity.

▼ Shown: PL20025-ASA and PL20014-ASA



- Provides continuous locking protection during lift, lower and hold functions
- Patent-pending control technology synchronizes cylinder and lock nut for smooth and efficient lifting and lowering
- Unique double-acting cylinder offers a low collapsed height to accommodate more lifting applications
- Simple 2-button pendant allows operation of raise and lower functions from up to 6,1 metres away
- All load-bearing cylinder components have a nitrocarburized treatment to improve wear characteristics and resist corrosion
- Ergonomic handle has six positions for comfortable handling and folds when not in use
- Meets ANSI/ASME B30.1-2015, AS/NZS-2538, AS/NZS-2693 certification criteria.



Efficient Lifting with Continuous Automatic Load Locking



POW'R-LOCK™ Self-Locking Lift System

Only the POW'R-LOCK™ Lift System provides continuous positive locking of the load through all stages of lifting and lowering. No operator intervention is required to activate or de-activate the automatic locking system.

Two different stroke lengths are available. Both models are powered by an external compressed air system (user-supplied).

A convenient two-button pendant controls operation of the Lift System's air motor and directional control valve.



Tilt Load Cap

All POW'R-LOCK™ Lift System models feature a Tilt Load Cap to reduce side-loading.



Safety First

When lifting large, heavy vehicles certain precautions must be followed. Follow your published safety directions for lifting and cribbing your loads. The Pow'R-LOCK™ Lift System provides load/lock protection, but you must follow the safety directions for load cribbing operations.

◀ The PL-Series POW'R-LOCK™ Portable Lift System.

POW'R-LOCK™ Mobile Lift System



Accessories

Flat Load Cap – Non-tilt load cap has lower profile for tight lifting spaces.

Spacers – Minimize gap between load cap and lifting point to maximize hydraulic stroke of the jack.

Extensions – Stackable, with large alloy steel locating studs to resist effects of side-loading.

Extension Base Adapter – Extension Base Adapter design eliminates risk of improper stacking when using more than one extension.

PL Series



Rated Lifting Capacity:

181 ton

Stroke:

356 - 622 mm

Maximum Operating Pressure:

700 bar

Model Number	Description	Height (mm)	PL20014-ASA	PL20025-ASA
PLC1	Flat Load Cap	34	x	x
PLS1	Spacer	26	x	x
PLS2	Spacer	51	x	x
PLE5	Extension	127	x	x
	PLE7	Extension	178	x
	PLE9	Extension	229	x
	PLE11	Extension	280	x
	PLE14	Extension	356	x
PLB12	Extension base adapter	305	x	-



WARNING!

PLE11 and PLE14 Extensions and PLB12 Extension Base Adapter are to be used with the "short" model **PL20014-ASA** only. Use of these extensions on the "tall" model **PL20025-ASA** will result in an excessive maximum lifting height. Load could become unstable and drop, resulting in possible personal injury and/or property damage.

Model Number	Maximum Additional Stack Height *
PLS20014-ASA	712 mm
PLS20025-ASA	229 mm

* Using optional PLB and PLE-Series extensions and PLS-Series spacers. Load cap height is NOT included in the stack height.

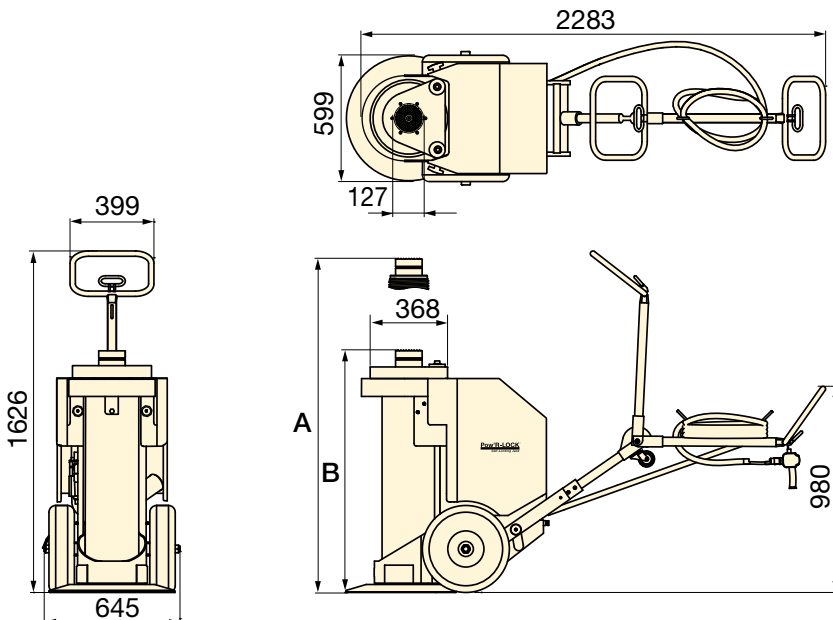

PR-Series, POW'R-RISER® Mobile Lifting Jack

When automatic load-locking is not required, the POW'R-RISER® jack provides a mobile lifting solution.

Page: 58

Capacity ton (kN)	Stroke (mm)	Model Number with Air Pump	Cylinder Lifting Speed ¹⁾ (mm/min)		Recommended Air Supply ²⁾		A ³⁾ (mm)	B ³⁾ (mm)	(kg)
			Load	No Load	(l/min)	(bar)			
181 (1779)	356	PL20014-ASA	51	61	3681 - 4247	3,8 - 6,9	1219	864	501
	622	PL20025-ASA	51	61			1778	1156	599

¹⁾ Depending on available airflow, regulator setting, pump speed and load weight.

²⁾ Minimum dynamic air pressure of 3,8-4,1 bar. 6,2-6,9 bar required to achieve 1779 kN capacity.

³⁾ Height A and B are with Swivel Load Cap installed. Subtract 51 mm if flat load cap is used.

▼ BLS-1006



- Climbing jacks include integral tilt saddles with maximum tilt angles up to 5 degree
- Large base with anti-rotation rod for stability and safety
- Built-in safety valve prevents accidental over-pressurization
- Ideal in combination with the stage lift work mode of the EVO-Series synchronous lifting system
- Baked enamel finish for increased corrosion resistance
- CR400 couplers included on all models.

▼ Synchronous Stage Lifting: 48 double-acting jacks (25 and 50 ton) are networked in to a 16 points synchronous system to lift this 50 metres long, 1000 ton building up to a height of 2,5 metres to construct a new floor level.



A Simple Solution to Incremental Lifting



Lifting Height

Climbing Jacks overcome the usual limitation of lifting height imposed by the cylinder's plunger stroke length. Large objects, such as oil tanks, can be lifted, held and lowered for maintenance without sending for a crane.



Split-Flow Pumps

SFP-Series Pumps with multiple outlets with equal oil flow. For lifting and lowering applications on multiple points Split-Flow Pumps are a far better alternative than using separately operated pumps.

Page: 236



Synchronous Lifting System

The standard EVO-Series System is ideal for stage lifting, powering interlinked hydraulic cylinders. The EVO-system has 9 work modes including the stage lift work mode.

Page: 240



Jack-Up Systems

For incremental lifting with higher lifting capacities and up to 20 m lifting height, see our JS-Series Jack-Up Systems.

Page: 244

Cylinder Capacity	Stroke	Model Number	Max. Cylinder Capacity (kN)	
			Push	Pull
ton	(mm)			
50	150	BLS-506	498	103
95	161	BLS-1006	933	435
140	151	BLS-1506	1386	668
200	151	BLS-2006	1995	1017

Double-Acting Climbing Jacks



◀ Typical stage-lift application using a custom built Enerpac system to lift the 360 ton Akkerwinde wooden bridge in the Netherlands.

BLS Series



Capacity per Lifting Point:

50 - 200 ton

Stroke per Stage:

150 - 161 mm

Maximum Operating Pressure:

700 bar

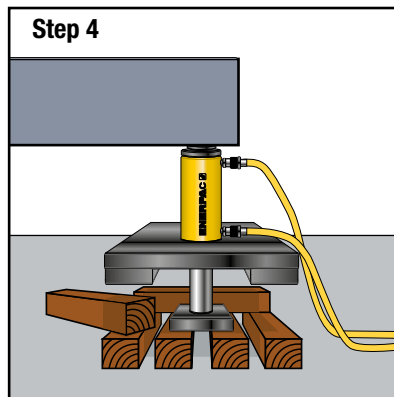
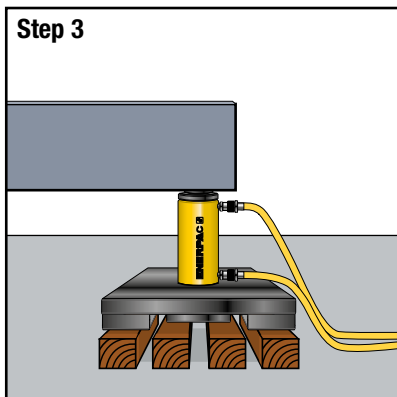
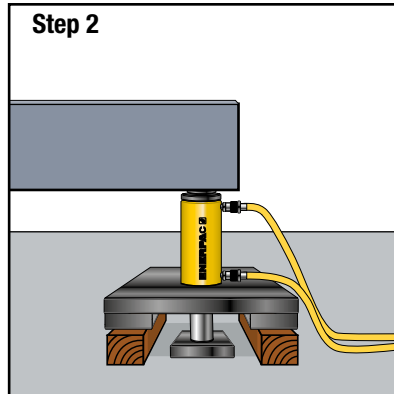
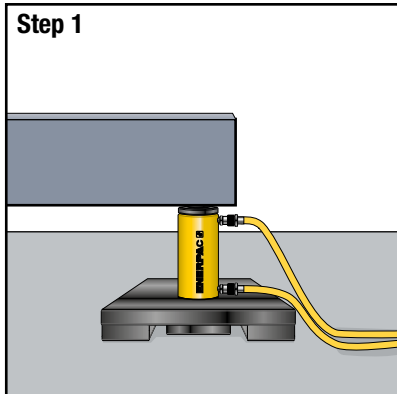

▲ Stage Lifting Sequence

Step 1: The climbing jack is placed on a solid support under the load (retracted plunger).

Step 2: Plunger extends, lifting the load and giving clearance to insert two outer blocks under the spreading plate.

Step 3: Plunger retracts, giving clearance to position the central blocks which will support the plunger plate for the next extension.

Step 4: Plunger extends, lifting the load, giving clearance to insert two new blocks, placed crosswise under the spreading plate.

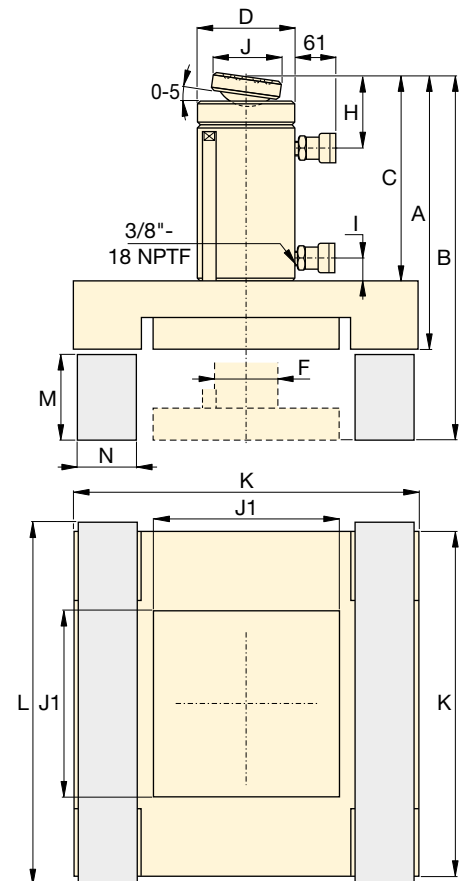

Cylinder Effective Area (cm ²)		Oil Capacity (cm ³)		Dimensions (mm)										Cribbing Blocks * and Dimensions (mm)			Model Number		
Push	Pull	Push	Pull	A	B	C	D	F	H	I	J	J1	K	Material	L	M	N	(kg)	
71,2	21,5	1111	335	406	556	318	127	79	56	36	50	240	515	Azobe	565	140	120	170	BLS-506
133,3	62,2	2238	1045	445	606	343	177	95	76	24	71	330	670	Wood	720	150	160	315	BLS-1006
198,1	95,4	3090	1488	472	624	370	203	114	94	39	130	230	475	Solid Aluminium or Steel	500	140	115	322	BLS-1506
285,6	145,6	4332	2209	510	661	387	248	133	102	37	130	270	550		575	140	135	373	BLS-2006

* Cribbing blocks are not supplied by Enerpac.